

Operating instructions

Switching actuator, 6-gang / blind actuator, 3-gang Standard
Order no. 5023 00

Switching actuator, 16-gang / blind actuator, 8-gang Standard
Order no. 5028 00

Switching actuator, 24-gang / blind actuator, 12-gang Standard
Order no. 5030 00

Table of Contents

1	Safety instructions	3
2	Device components	3
3	Function	3
4	Operation	5
5	Information for electrically skilled persons	9
	5.1 Mounting and electrical connection	9
	5.2 Commissioning	11
	5.3 Optional: Installing the phase busbar (accessory)	12
6	Technical data	12
7	Parameter list	14
8	Accessories	17
9	Warranty	17

1 Safety instructions



Electrical devices may be mounted and connected only by electrically skilled persons.

Serious injuries, fire or property damage are possible. Please read and follow the manual fully.

Danger of electric shock on the SELV/PELV installation. Do not connect loads for mains voltage and SELV/PELV together to the device.

For parallel connection of several motors to an output it is essential to observe the corresponding instructions of the manufacturers, and to use a cut-off relay if necessary. The motors may be destroyed.

Use only venetian blind motors with mechanical or electronic limit switches. Check the limit switches for correct mastering. Observe the specifications of the motor manufacturers. Device can be damaged.

Do not connect any three-phase motors. Device can be damaged.

These instructions are an integral part of the product, and must remain with the end customer.

2 Device components

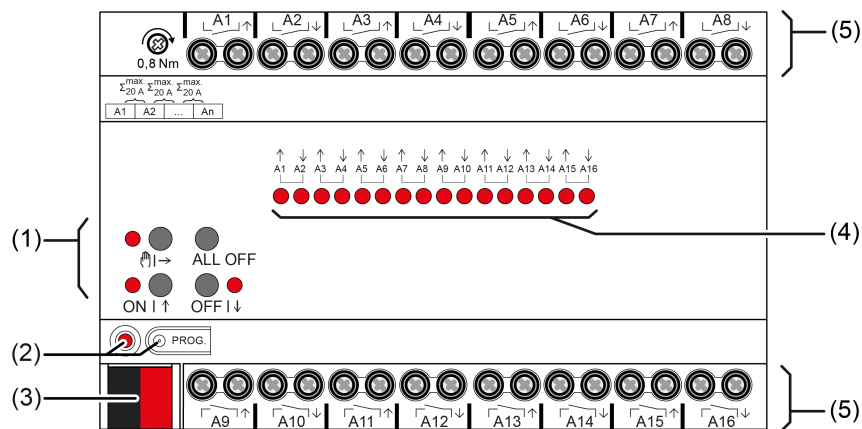

Figure 1: Device components

- (1) Button field for manual operation
- (2) Programming button and LED
- (3) Bus connection
- (4) Status LEDs for outputs
- (5) Load connections (relay outputs)

3 Function

This device is a product for the Gira One Smart Home system. The Gira One system is commissioned easily and in a time-saving manner using the Gira Project Assistant.

The Gira One Smart Home system enables the control and automation of lighting, heating and shading, as well as connection to various third-party systems and much more. It can be operated via Gira One switches, by app from home or securely from a remote location. Electrically skilled persons can maintain the Gira One project remotely free of charge.

Data transmission between the Gira One devices is encrypted. This provides protection against third-party access and manipulation.

Commissioning is carried out with the free Gira Project Assistant (GPA), version 5 or higher. Free function and security updates are also transferred to the Gira One devices with the GPA.

The Gira One system is based on the globally proven KNX smart home standard.

Intended use

- Switching of electrical loads with potential-free contacts
- Switching of electrically-driven Venetian blinds, roller shutters, awnings and similar hangings
- Installation in sub-distribution unit on DIN rail according to DIN EN 60715
- Operation in Gira One system

Product characteristics

- Outputs can be operated manually, construction site mode
- Manual switching between Venetian blind operation and switching operation without commissioning
- Programming and commissioning with the Gira Project Assistant (GPA), version 5 or higher.
- Updating via the Gira Project Assistant (GPA).
- Encrypted data transmission between the Gira One devices.

Characteristics switch operation

- Operation as NO or NC contacts
- Setting of a switch-on or switch-off delay.
- Staircase function for which a pre-warning time can additionally be set.
- Configuration as a switching function, e.g. for a light or sockets, as a garage door function or door opener function, and as a potential-free switching contact for transmission of the heat requirement to a heat pump.
- Garage door function: The time for closing the relay can be configured.
- Door opener function: The time for closing the relay can be configured.

Characteristics Venetian blinds operation

- Suitable for AC motors 110...230 V
- Control of blinds with slats, shutters, awnings, roof windows or roof domes.

- Travelling times can optionally be set.
- Sun protection function with blind or slat positions at the beginning and at the end of the function can be set separately for each output.
- Setting of the delay time at the beginning or end of sunshine.
- Fabric stretching for awnings.
- If a wind alarm is active (e.g. as the result of an analogue wind sensor), the Venetian blinds are raised and automatically locked. The status of the binary input connected to the wind sensor is monitored cyclically.
- If a rain alarm is active (e.g. as the result of an analogue rain sensor), roof windows or roof domes are closed and automatically locked. The status of the binary input connected to the rain sensor is monitored cyclically.
- If a frost alarm is active (e.g. as the result of an analogue frost sensor), active movements of shutters are stopped and disabled to protect the shutter motor. The status of the binary input connected to the rain sensor is monitored cyclically.
- Door contact polling and visualisation in the Smart Home app: An open door leads to the Venetian blind or shutters being raised and locked.

4 Operation

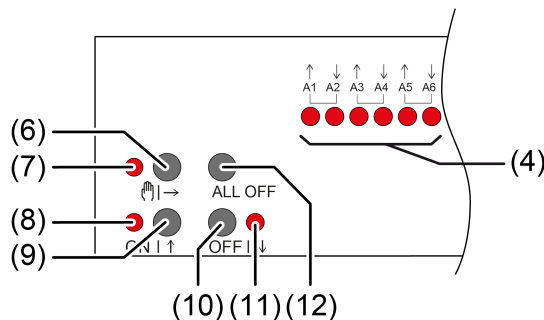

Figure 2: Operating elements

- (4) Status LEDs for outputs
ON: Relay output closed
OFF: Relay output opened
Flashes slowly: Output in manual mode selected
Flashes quickly: Output disabled via continuous manual mode
- (6) Button →
Manual operation
- (7) LED →
ON: Continuous manual mode active/Flashing: Temporary manual mode active
- (8) LED **ON** | ↑
ON: Relay outputs closed, manual mode active
- (9) Button **ON** | ↑
Short: Switch on, adjust slats or stop
Long: Move hanging upwards

- (10) Button **OFF**↓
Short: Switch off, adjust slats or stop
Long: Move hanging downwards
- (11) LED **OFF**↓
ON: Relay outputs opened, manual mode active
- (12) Button **ALL OFF**
Open all relay outputs, stop drives

In operation with the button field the device distinguishes between a short and a long press.

- Short: Pressing for less than 1 s
- Long: Pressing for between 1 and 5 s

- i** In switching operation, the device distinguishes between the "NO contact" and "NC contact" operating modes. The buttons (9 + 10) switch the switching state when actuated:
- NO contact: Switch on = close relay, Switch off = open relay
 - NC contact: Switch on = open relay, Switch off = close relay
- The LED (4 + 8 + 11) always indicate the relay state.

Operating modes



- Bus operation: operation via push-button sensors or other bus devices
- Temporary manual control: manual control locally with keypad, automatic return to bus control
- Continuous manual mode: exclusively manual operation on the device

- i** No bus operation is possible in manual mode.

- i** After a bus failure and restoration the device switches to bus operation.

Switching on temporary manual operation mode

Operation is not disabled.

- Press button  (6) briefly.
LED  (7) flashes, LEDs **A1...** (4) of the first configured output or output pair flash.

Short-time manual operation is switched on.

- i** After 5 s without a button actuation, the actuator returns automatically to bus operation.

Switching off temporary manual operation mode

The device is in short-term manual mode.

- No button-press for 5 s.
- or -

- Press **↵** (6) button briefly as many time as necessary until the actuator leaves the short-time manual mode.

Status LEDs **A1...** (4) no longer flash, but rather indicate the relay status.

Short-time manual operation is switched off.

Switching outputs: depending on the programming, the output relays switch to the position that is active after the manual mode is switched off.

Venetian blind outputs: depending on the programming, the blind moves to the position that is active after the manual mode is switched off, e.g. to safety or sun protection position.

Switching on permanent manual operation mode

Operation is not disabled.

- Press the **↵** (6) button for at least 5 s.

LED **↵** (7) lights up, LEDs **A1...** (4) of the first configured output or output pair flash.

Continuous manual mode is switched on.

Switching off permanent manual operation mode

The device is in continuous manual mode.

- Press the **↵** (6) button for at least 5 s.

LED **↵** (7) is off.

Continuous manual mode is switched off. Bus operation is switched on.

Switching outputs: depending on the programming, the output relays switch to the position that is active after the manual mode is switched off.

Venetian blind outputs: depending on the programming, the blind moves to the position that is active after the manual mode is switched off, e.g. to safety or sun protection position.

Operating an output in manual mode

- Activate short-term or permanent manual operation.
- Keep pressing the **↵** button (6) until the LED **A1...** (4) of the desired output or output pair flashes.

- Press the **ON** (9) or **OFF** (10) button.
Short: Switch on/off, drive stop.
Long: Move blind/shutter upwards/downwards.

LED **ON** (8) ON: Relay output closed

LED **OFF** (7) OFF: Relay output opened

- i** Short-term manual mode: After running through all of the outputs the device exits manual mode after another brief actuation.



Switching off all outputs / Stopping all hangings

The device is in permanent manual operation mode.

- Press the **ALL OFF** button (12).
Switching outputs: all outputs switch off (NO operating mode: relay output opened/NC operating mode: relay output closed).
Venetian blind outputs: all blinds/shutters stop.

Disabling outputs

The device is in continuous manual mode.



- Press button  (6) repeatedly until LED **A1...** (4) of the desired output or output pair flashes.
- Press the **ON**  (9) and **OFF**  (10) buttons simultaneously for approx. 5 s.
Selected output is disabled.

The status LED **A1...** (4) of the selected output or output pair flashes quickly.

- i** A disabled output can be operated in manual mode.

Re-enabling outputs





The device is in permanent manual operation mode. One or more outputs were disabled in manual mode.

- Press button  (6) repeatedly until the output to be unlocked or the output pair is selected.
- Press the **ON**  (9) and **OFF**  (10) buttons simultaneously for approx. 5 s.
Disabling is deactivated.

The LED **A1...** (4) of the selected output or output pair flashes slowly.



Switching between Venetian blind and switching operation

Device is not in operation

- Activate permanent manual operation.
- Keep pressing the  button (1) until the LED **A1...** (8) of the desired output or output pair flashes.
- Press the  (1) and **ON**  (4) and **OFF**  (5) buttons simultaneously for approx. 5 s.

Switching operation: Both status LEDs **A1...** (8) of the output pair light up.

Venetian blind operation: Both status LEDs **A1...** (8) of the output pair flash alternately.

- Press the **ON**|↑ (4) and **OFF**|↓ (5) buttons simultaneously.
Outputs switch between switching operation and Venetian blind operation.
Both status LEDs **A1**... (8) indicate the current operating mode.
- Press the |→ (1) and **ON**|↑ (4) and **OFF**|↓ (5) buttons simultaneously for approx. 5 s.
Operating mode switchover is terminated, permanent manual operation mode is activated.
- Press the |→ button (1) for approx. 5 s.
Operating mode switchover is terminated, permanent manual operation mode is deactivated.

5 Information for electrically skilled persons



DANGER!

Mortal danger of electric shock.

Disconnect the device. Cover up live parts.

5.1 Mounting and electrical connection

Mount device

- Enter or scan the device certificate and add it to the project. A high resolution camera should be used to scan the QR code.
- The device certificate should be removed from the device during mounting.
- Document all passwords and keep them safe.

Observe the ambient temperature. Ensure sufficient cooling.

- Mount device on DIN rail.

Connecting the device

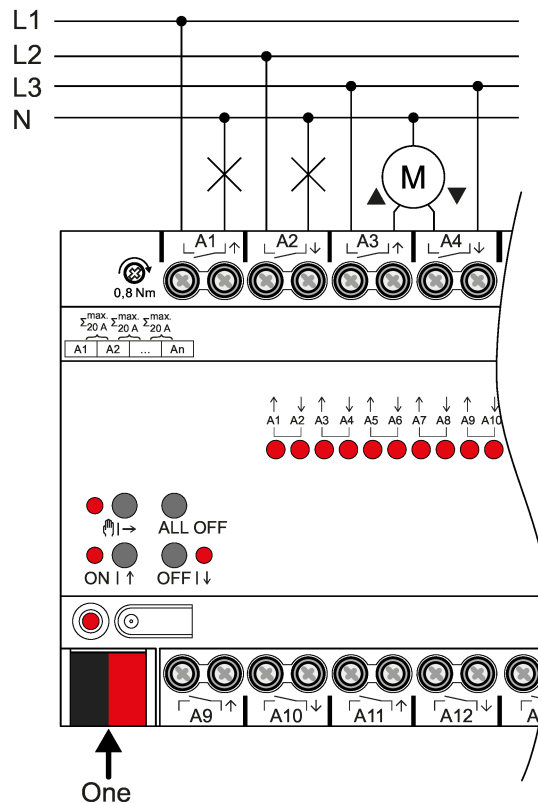

Figure 3: Device connection (connection example)

- Connect bus line with device connection terminal observing the correct polarity.
- Attach the cover cap to the bus connection as protection against hazardous voltages.
- Connect load as shown in the connection example. Two adjacent relay outputs form a Venetian blind output.

The total current capacity of neighbouring outputs is a maximum of 20 A.

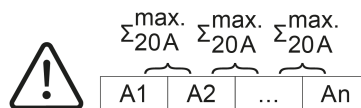

Figure 4: Total current capacity of neighbouring outputs

5.2 Commissioning

Commissioning the device



NOTICE!

Incorrect load control due to undefined relay state at delivery.

Risk of destruction of connected drive motors.

During commissioning, before switching on the load, ensure that all relay contacts are open by applying the bus voltage. Observe commissioning sequence!

- Switch on the bus voltage.
- Wait about 10 s.
- Switch on load circuits.

i Delivery state: The outputs can be operated with manual control. Outputs are set as Venetian blind outputs.

The device is commissioned with the Gira Project Assistant (GPA) version 5 or higher.

Safe-state mode

The safe-state mode stops the execution of the program.

Only the system software of the device is still functional. Diagnosis functions and programming of the device are possible. Manual operation is not possible.

Activating safe-state mode

- Switch off the bus voltage or remove the device connection terminal.
- Wait about 15 s.
- Press and hold down the programming button.
- Switch on the bus voltage or attach the device connection terminal. Release the programming button only after the programming LED starts flashing slowly.

The safe-state mode is activated.

Deactivating safe-state mode

- Switch off the bus voltage (wait approx. 15 s) or carry out programming.

Master reset

The master reset restores the basic device settings (firmware remains in place). The device must then be recommissioned with the GPA. Manual operation is possible.

Performing a master reset

Precondition: The safe-state mode is activated.

- Press and hold down the programming button for > 5 s.
The programming LED flashes quickly.

The device performs a master reset, restarts and is ready for operation again after approx. 5 s.

5.3 Optional: Installing the phase busbar (accessory)

- If necessary, cut the phase busbar at the notches using diagonal cutting pliers (see figure 5).
- Attach the end cap to the interface.

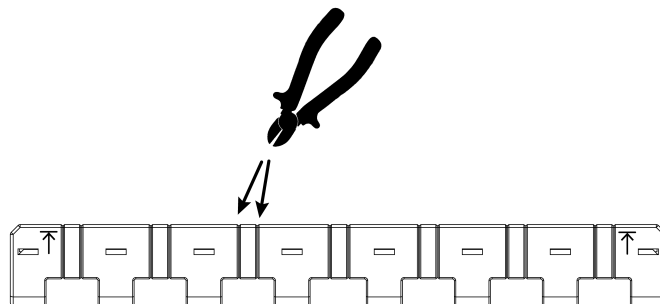

Figure 5: Shortening the phase busbar

- i** Ensure that the device connection terminals are open and the copper pins are inserted in the device connection terminals.
- Align the phase busbar using the printed arrows and plug it into the device connection terminals (see figure 6).
- Screw the phase busbar to the device connection terminals.

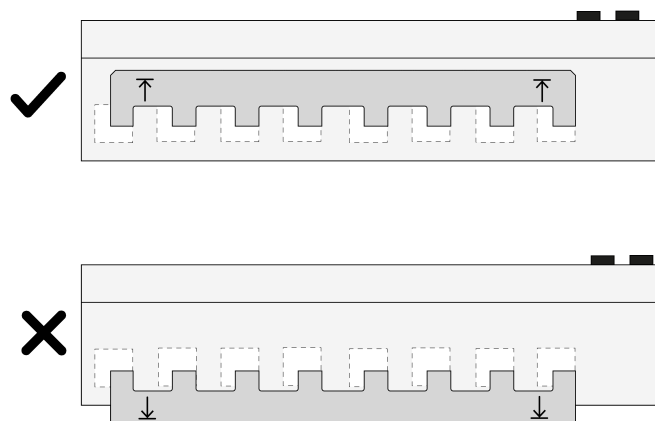

Figure 6: Installing the phase busbar

6 Technical data

Rated voltage	DC 21 ... 32 V SELV
Current consumption	
Order no. 5023 00, 5028 00	5 ... 18 mA

Order no. 5030 00	5 ... 24 mA
Outputs	
Switching voltage	AC 250 V ~
Switching current AC1	16 A
Fluorescent lamps	16 AX
Current carrying capacity	
Neighbouring outputs	Σ 20 A
Loads per output	
Ohmic load	3000 W
Capacitive load	max. 16 A (140 µF)
Motors	1380 VA
Switch-on current 200 µs	Max. 800 A
Switch-on current 20 ms	Max. 165 A
Lamp loads	
Incandescent lamps	2300 W
HV halogen lamps	2300 W
HV-LED lamps	Max. 400 W
LV halogen lamps with electronic transformers	1500 W
LV halogen lamps with inductive transformer	1200 VA
Compact fluorescent lamps	
uncompensated	1000 W
parallel compensated	1160 W (140 µF)
Installation width	
Order no. 5023 00	72 mm / 4 HP
Order no. 5028 00	144 mm / 8 HP
Order no. 5030 00	216 mm / 12 HP
Weight	
Order no. 5023 00	approx. 230 g
Order no. 5028 00	approx. 500 g
Order no. 5030 00	approx. 740 g
Clampable conductor cross-section	
Single stranded	0.5 ... 4 mm ²
Finely stranded without conductor sleeve	0.5 ... 4 mm ²
Finely stranded with conductor sleeve	0.5 ... 2.5 mm ²
Ambient conditions	

Ambient temperature	-5 ... +45 °C
Storage/transport temperature	-25 ... +70 °C
Connection torque for screw terminals	Max. 0.8 Nm

7 Parameter list

Parameters that can be set via the GPA:

Output - Switching functions

Function of the switching output	NO contact NC contact
<p>NO contact The relay works as an NO contact. The logical switching state of the switching output is not forwarded to the relay in inverted form. Switching state = OFF ("0") -> relay contact open, Switching state = ON ("1") -> relay contact closed.</p> <p>NC contact The relay works as an NC contact. The logical switching state of the switching output is forwarded to the relay in inverted form. Switching state = OFF ("0") -> relay contact closed, Switching state = ON ("1") -> relay contact open.</p>	
Switch-on delay	0 ... 3599 s (0 ... 59:59 min)
<p>This parameter is used for setting the duration of the switch-on delay. After receipt of an ON-telegram, the time that can be configured here is started. The lamp is switched on after the set time has elapsed. A further ON-telegram during the switch-on delay time re-triggers the time, i.e. the time set here is started again. An OFF-telegram received during the ON-delay will end the delay and sets the switching status to "OFF".</p>	
Switch-off delay	0 ... 3599 s (0 ... 59:59 min)
<p>This parameter is used for setting the duration of the switch-off delay. After receipt of an OFF-telegram, the time that can be configured here is started. The lamp is switched off after the set time has elapsed. A further OFF-telegram during the switch-off delay time re-triggers the time, i.e. the time set here is started again. An ON-telegram received during the OFF-delay will end the delay and sets the switching status to "ON".</p>	

Staircase switch Switch-off delay	0 ... 65535 s (0 ... 18:12:15 h)
<p>The duration of the switch-on time for the staircase function is configured here.</p> <p>Once the time set here has elapsed, the lighting is switched off or (if configured) the pre-warning time is started.</p> <p>The staircase function is only active if the function "Staircase" has been selected for the push-button of this dimming channel.</p>	
Pre-warning time	0 ... 3599 s (0 ... 59:59 min)
<p>In accordance with DIN 18015-2, the pre-warning is intended to warn persons still on the staircase that the light will soon be switched off automatically.</p> <p>The pre-warning time set here is added to the time set in the parameter "Staircase switch switch-off delay".</p>	
Switching time	0 ... 65535 s (0 ... 18.20 h)
<p>The switching time in seconds can be specified here.</p>	

Output - Blind functions

No travelling time	
<p>If this option is activated, no explicit travelling times can be set for the blind/shutter. Preset travelling times are used instead.</p> <p>This has the result that it is not possible to move this blind/shutter to defined positions (e.g. 60%).</p>	
Downwards travelling time	0 ... 1199 s (0 ... 19:59 min)
<p>This parameter defines the travelling time for closing the blind/shutter. The time needed for a complete travel from the upper into the lower end position must be determined.</p>	
Upwards travelling time	0 ... 1199 s (0 ... 19:59 min)
<p>This parameter defines the travelling time for opening the blind/shutter. The time needed for a complete travel from the lower into the upper end position must be determined.</p>	
Slats travelling time (for Venetian blinds only)	0 ... 1199 s (0 ... 19:59 min)
<p>This parameter defines the travel time of the slats. The time needed for a complete movement from the completely open slat position into the completely closed slat position (travel movement DOWN) must be determined.</p> <p>This parameter is only visible in the Venetian blind operating mode.</p>	

Time for fabric stretching (for awnings only)	0...59 s
<p>The time for fabric stretching can be specified here. After the end of a downward movement, the awning stops and – after the switchover time has elapsed – moves in the opposite direction for a period corresponding to the fabric stretching time configured here.</p> <p>This parameter is only visible in the awning operating mode.</p>	
Delay at the beginning of sunshine	0 ... 3599 s (0 ... 59:59 min)
<p>The telegram received via the object "Sunshine" for activation of the sun protection can be evaluated with a time delay.</p>	
Venetian blind position at the beginning of sunshine	0 ...100 %
<p>The blind/shutter position to which the blind/shutter is to be moved if sun protection has been activated can be defined here.</p>	
Slat position at the beginning of sunshine (for Venetian blinds only)	0 ...100 %
<p>The slat position to which the slats are to be set if sun protection has been activated can be defined here.</p> <p>This parameter is only visible in the Venetian blind operating mode.</p>	
Delay at the end of sunshine	0 ... 3599 s (0 ... 59:59 min)
<p>The telegram received via the object "Sunshine" for deactivation of the sun protection can be evaluated with a time delay.</p>	

At the end of sunshine	no reaction raising lowering stop Last position before sunshine
<p>This parameter defines the behaviour of the output at the end of shading – if applicable, after the end of the delay time.</p> <p>no reaction At the end of shading, the output quits the sun protection mode and the relays of the output show no reaction. Any travel movements still in progress at this instant will still be finished.</p> <p>raising At the end of shading, the actuator raises the blind/shutter or opens the venting louvre/roof window.</p> <p>lowering At the end of shading, the actuator lowers the blind/shutter or closes the venting louvre/roof window.</p> <p>stop At the end of shading, the actuator switches the relays of the output to the "stop" position. A travel movement, if any, will be interrupted.</p> <p>Last position before sunshine At the end of shading, the blind/shutter moves back to the position that was active at the beginning of sunshine.</p>	

8 Accessories

Set of 1-pole phase busbars for 16-gang switch actuator / 8-gang Venetian blind actuator, for Gira One and KNX	Order no. 8313 00
Set of 1-pole phase busbars for 24-gang switch actuator / 12-gang Venetian blind actuator, for Gira One and KNX	Order no. 8314 00
Set of end caps for phase busbar	Order no. 8315 00

9 Warranty

The warranty is provided by the specialist trade in accordance with statutory requirements. Please submit or send faulty devices postage paid together with a fault description to your responsible salesperson (specialist trade / installation company / electrical specialist trade). They will forward the devices to the Gira Service Center.

Gira
Giersiepen GmbH & Co. KG
Elektro-Installations-
Systeme

Industriegebiet Mermbach

Dahlienstraße
42477 Radevormwald

Postfach 12 20
42461 Radevormwald

Deutschland

Tel +49(0)21 95 - 602-0
Fax +49(0)21 95 - 602-191

www.gira.de
info@gira.de