

Operating Instructions

Transponder Reader
2606 ..

GIRA

Contents

Device description	5
Device presentation	6
Areas of application	8
Operation	10
Acknowledgement signals	12
Start-up sequence	13
Connection terminals	14
Installation	15
Information on programming	16
Assigning programming card	17
Assigning transponder key to relay 1 (far field)	18
Assigning transponder key to relay 2 (near field)	19
Assigning transponder key to relays 1 + 2	20
Deleting transponder key/transponder card	21
Setting switching time of relays	22
Switching acknowledgement tones on/off	23
Setting range of far field	24
Reset to factory settings – delete all assignments	25
Integration in the door communication system	26
Connection to door communication system	27
Assigning transponder key with a far field function to a switching actuator/door opener	29
Assigning transponder key with near field function to a switching actuator/door opener	31

Assigning transponder key with near and far field function to a switching actuator/door opener	33
Deleting assignment of transponder key - switching actuator/door opener	35
Relays / actuators – what switches when?	37
5 rules for selecting the correct mode	38
Assigning mode to a transponder key	39
Changing mode of a key group	40
Examples	
Example 1: Start-up stand-alone function	41
Example 2: Start-up door communication system	43
Example 3: Integrating in door communication system without speech function	46
Activation input	47
Relay of transponder reader	48
Changing battery of transponder key	49
Storing of transponder keys	50
Procedure with loss of programming card	51
Behaviour with excess temperature	52
Technical data	53
Warranty	54

Device description

The transponder reader features long-range transponder technology with convenient access control for inside and outside areas. The transponder reader responds to the signal from the active transponder key or the transponder card. The Transponder key is activated upon being approached from as far away as 1.5 metres (far field). In addition, a near field function (approx. 10 cm) can be used with the transponder reader. The transponder reader can be used as a stand-alone function, e.g. at individual doors or gates. It can also be integrated into the Gira door communication system.

Both integrated zero-voltage two-way switch relays can be assigned different switching processes, e.g. relay 1 (far field) for door opening and relay 2 (near field) for switching the outside light.

The transponder reader can manage up to 250 transponder keys or transponder cards. These can be taught in via direct configuration at the device without a PC or programming software. Each transponder key and transponder card has its own code, and is thus unique.

The transponder reader is installed indoors (IP 20) in conjunction with System 55 cover frames, and outdoors (IP 44) with TX_44 cover frames.

Device presentation

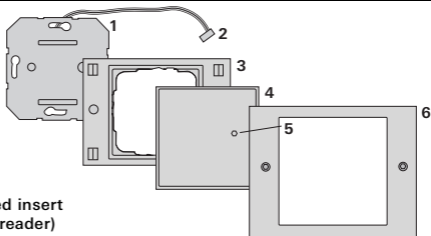

TX_44

- 1 Flush-mounted insert (transponder reader)
- 2 Connection cable for door communication system
- 3 TX_44 cover frame, bottom section (not included in scope of supply)
- 4 Transponder cover plate
- 5 Status LED
- 6 TX_44 cover frame, top section (not included in scope of supply)

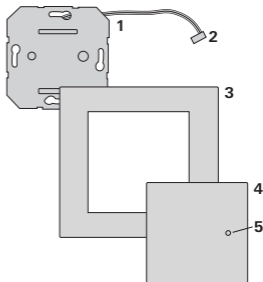

System 55

- 1 Flush-mounted insert (transponder reader)
- 2 Connection cable for door communication system
- 3 System 55 cover frame (not in scope of supply)
- 4 Transponder cover plate
- 5 Status LED

The programming card

For start-up and configuration of the transponder reader a programming card is necessary.

The programming card functions only in the near field of the transponder reader and cannot be used for switching actions. A programming card can be assigned several transponder readers, so that with several transponder readers only one programming card is needed.

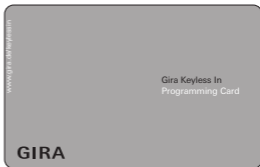

Transponder key and transponder card

The battery-operated transponder key is an active transponder that can trigger both far field and near field functions.

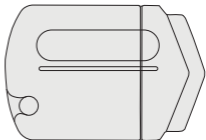

The transponder card is a passive transponder and can only trigger functions in the near field.

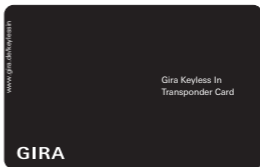

Areas of application

Use as individual device

In this case the existing zero-voltage relay contacts within the flush-mounted insert are used, e.g. for a door opener with own power supply.



Unsuitable for use as individual device in safety-relevant areas

Not recommended for opening of outside doors especially in safety-relevant areas, as door may be opened when transponder reader is expanded via bridging of open contacts.

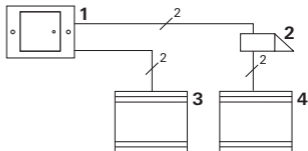

- 1 Transponder reader
- 2 Door opener
- 3 Power supply
24 V DC
- 4 Power supply
of door opener



Door opener with separate power supply

A door opener connected at the relays of the transponder reader should be connected to a separate power supply.

Use in door communication system

The transponder reader can be connected to the door communication system via the enclosed connection cable. Thus the transponder reader can control e.g. the door opener contact of the control device or can trigger the switching action of a switching actuator.

- 1 Hands-free feature surface-mounted home station
- 2 Flush-mounted door station with transponder reader
- 3 Power supply 24 V DC
- 4 Audio control device
- 5 Door opener

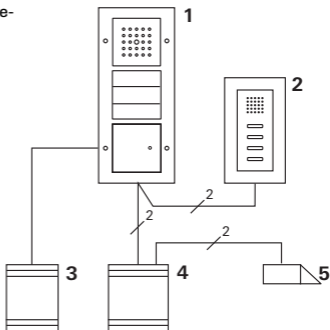

Protecting control device from unauthorised access

In safety-relevant areas the control device should be securely installed (locked) to prevent unauthorised access.

Operation

Far field

For operation in a far field, the transponder key must enter the far field area.

When the transponder key is recognised the previously specified switching action is executed with a positive acknowledgement signal.

An unauthorised or unassigned transponder key is indicated with a negative acknowledgement signal.



Emergency mode with weak transponder key battery

With a weak battery the far field function can be triggered with a prolonged holding within the near field (> 3 secs.).



Storing of transponder keys

Transponder keys should not be kept permanently within the detection range of the far field. Details are provided on Page 50.

Near field

To trigger the switching function of the near field, the transponder key or transponder card is held briefly in front of the transponder reader.

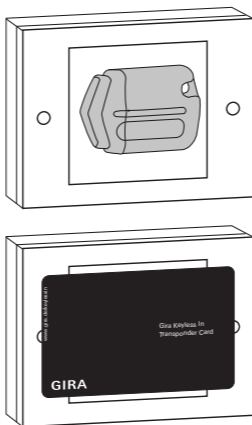

When the transponder key (or transponder card) is recognised, the previously specified switching action is executed with a positive acknowledgement signal.

An unauthorised or unassigned transponder key (or transponder card) is indicated with a negative acknowledgement signal.

Acknowledgement signals

The transponder reader generates different acknowledgement signals during operation and start-up:

Positive acknowledgement signal

- ✓ The transponder reader generates a long acknowledgement tone, the LED simultaneously lights up green.

Negative acknowledgement signal

- ✓ The transponder reader generates 3 short acknowledgement tones, the LED simultaneously lights up red.

Programming mode activated

- ✓ The LED lights up orange.

In door communication system:

Programming mode activated

- ✓ The transponder reader generates a short acknowledgement tone, the LED flashes orange.

Programming mode terminated

- ✓ The transponder reader generates a short acknowledgement tone, the LED is off.



Acknowledgement tones can be switched off

Acknowledgement tones occurring during operation can be switched off (see Page 23).

Start-up sequence

For start-up the transponder reader, the following steps must be implemented in the order shown below:

- | | |
|---|------------|
| I. Install transponder reader (from Page 14)
→ LED flashes green | I |
| II. Assign programming card (Page 17)
- Hold programming card for 3 seconds in front | II |
| III. Create transponder for relay 1/2 (from Page 18)
- Prog. card 3 secs, then hold transponder in front
(1 time = R1, 2 times = R2, 3 times = R1+2) | III |
| IV. Carry out configurations to transponder reader (from Page 21) | IV |
| V. Use in door communication system
Assigning door opener / switching actuators (from Page 26) | V |

Connection terminals



Attention

Installation and mounting of electrical devices may only be carried out by a qualified electrician.

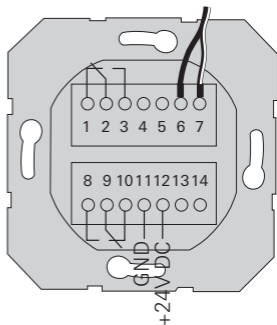

Relay 1	1	Relay 1 N.C. (NC contact)
	2	Relay 1 COM
	3	Relay 1 N.O. (NO contact)
Service	4	not used
	5	not used
Door communication (pre-assembled)	6	GND for Gira door communication
	7	COM bus Gira door communication
Relay 2	8	Relay 2 N.O. (NO contact)
	9	Relay 2 COM
	10	Relay 2 N.C. (NC contact)
Power supply	11	GND
	12	+ 24 V DC
Activation input	13	GND for activation input
	14	Activation input

Installation

1. Pull off required terminal strip from the flush-mounted insert and connect according to terminal figuration.
2. Attach the terminal strip to the flush-mounted insert again.
3. Install flush-mounted insert into the 58 mm flush-mounted box.
4. Install cover frame and attach cover plate of the reader.
- ✓ 10 seconds after operating voltage is applied, the LED of the transponder reader flashes green.
5. Start-up the transponder reader:
 - first assign the programming card (Page 17),
 - then assign the transponder key or card (from Page 18),
 - then if necessary assign switching actuator functions or door opener functions (from Page 29).



Installation notes

- A minimum distance of 3 m is to be maintained between two transponder readers.
- The transponder reader must always be mounted with the support ring on wallpaper.
- For installation in TX_44 cover frames, the cover frame bottom section must be fastened to the wall (screw/dowel). Do **not** use the seals included with the TX_44 cover frame.

Information on programming

Please note the following information concerning programming of the transponder reader:

- Before the transponder reader is switched to programming mode, no transponder key must be present within the detection range (otherwise the programming card may not be recognised).
- In programming mode the range of the transponder reader is reduced to the near field so that no undesired transponder keys are taught in.
- A pause of at least 1 second must be kept between individual programming steps. The transponder reader requires this time span to ensure that no transponder key (or transponder card) is within the near field. During this time the corresponding transponder key (or transponder card) must be removed from the near field. It is important to wait for the full acknowledgement tone before the transponder key is held in front of the transponder reader.
- Several transponder keys can be taught in in one procedure.
- If no action is executed, the transponder reader terminates the programming mode after 10 seconds with a negative acknowledgement signal.

Assigning programming card

In delivery state, the transponder reader has not been assigned a programming card. In this case the LED of the transponder reader flashes green.

During first start-up the programming card must first be assigned to the transponder reader:

✓ The LED flashes green.

1. Hold **the programming card 3 seconds** in front of the transponder reader until a positive acknowledgement signal is generated.

✓ After 1 second the green LED goes out.

The programming card is permanently assigned to this transponder reader.



One programming card per transponder reader

It is not possible to assign several programming cards to one transponder reader.

The programming card cannot be used for subsequent switching actions.

Assign transponder key to relay 1 (far field)

1. Hold **the programming card 3 seconds** in front of the transponder reader until an acknowledgement tone is generated.
 - ✓ A further acknowledgement tone follows, the LED flashes green once and then lights up orange.
2. Hold the **programming card once** in front of the transponder reader until an acknowledgement tone is generated and the LED flashes green.
 - ✓ The transponder key is assigned to the transponder reader and switches relay 1 in the far field.
 - ✓ Further transponder keys can be assigned (without action the programming mode is terminated automatically after 2 minutes).
3. Hold the programming card briefly in front to terminate the programming mode with a positive acknowledgement signal.



Assign transponder card to relay 1

The transponder card switches relay 1 in the near field.
The transponder card is assigned as described above.

Assign transponder card to relay 2 (near field)

1. Hold the **programming card 3 seconds** in front of the transponder reader until an acknowledgement tone is generated.
 - ✓ A further acknowledgement tone follows, the LED flashes green once and then lights up orange.
2. Hold the **transponder card to be assigned 2 times** with a pause of 1 second each time in front of the transponder reader:
 - 1st time → 1 acknowledgement tone - LED flashes green.
 - 2nd time → 2 acknowledgement tones - LED flashes green twice.
 - ✓ The transponder card is assigned to the transponder reader and switches relay 2 in the near field.
 - ✓ Further transponder keys or cards can be assigned (without action the programming mode is terminated automatically after 2 minutes).
3. Hold the programming card briefly in front to terminate the programming mode with a positive acknowledgement signal.



Assigning transponder key to relay 2

The transponder key switches relay 2 in the near field. The transponder key is assigned as described above.

Assign transponder key to relays 1 + 2

1. Hold the **programming card 3 seconds** in front of the transponder reader until an acknowledgement tone is generated.
 - ✓ A further acknowledgement tone follows, the LED flashes green once and then lights up orange.
2. Hold the **transponder card to be assigned 3 times** with a pause of 1 second each time in front of the transponder reader:
 - ✓ 1st time → 1 acknowledgement tone - LED flashes green once.
 - 2nd time → 2 acknowledgement tones - LED flashes green twice.
 - 3rd time → 3 acknowledgement tones - LED flashes green three times.
- III ✓ The transponder key is assigned to the transponder reader and switches relay 1 in the far field and relay 2 in the near field.
- ✓ Further transponder keys or cards can be assigned (without action the programming mode is terminated automatically after 2 minutes).
3. Hold the programming card briefly in front to terminate the programming mode with a positive acknowledgement signal.



Assign transponder card to relays 1 + 2

The transponder card switches both relays in the near field. The transponder card is assigned as described above.

Deleting transponder key/transponder card

1. Hold the **programming card 3 seconds** in front of the transponder reader until an acknowledgement tone is generated.
 - ✓ A further acknowledgement tone follows, the LED flashes green once and then lights up orange.
2. Hold the **transponder key/card to be deleted 4 times** with a pause of 1 second each time in front of the transponder reader:
 - ✓ 1st time → 1 acknowledgement tone - LED flashes green once,
 - 2nd time → 2 acknowledgement tones - LED flashes green twice,
 - 3rd time → 3 acknowledgement tones - LED flashes green three times,
 - 4th time → 4 acknowledgement tones - LED flashes green four times.
 - ✓ The transponder key/card is deleted.
 - ✓ Further transponder keys or cards can be deleted (without action the programming mode is terminated automatically after 2 minutes).
3. Hold the programming card briefly in front to terminate the programming mode with a positive acknowledgement signal.

Setting switching time of relays

The contact hold time of the relays can be set from 3 to 30 seconds. The set contact hold time is valid for both the near field relay and the far field relay.

The contact hold time of the relays is set as follows:

1. Hold the **programming card 6 seconds** in front of the transponder reader until the second acknowledgement tone is heard. After 3 seconds the first acknowledgement tone comes, please wait for the second acknowledgement tone.
 - ✓ The LED flashes green once and then flashes green twice.
2. To start the switching time hold the **programming card** again briefly in front of the transponder reader.
 - ✓ The transponder reader generates an acknowledgement tone every second and simultaneously flashes green. The relays are not activated during setting of the hold time.
3. For terminating the setting of the switching time hold the **programming card** again briefly in front of the transponder reader.
 - ✓ The transponder reader generates a positive acknowledgement signal.



Acknowledgement tone with programming

While the transponder reader is being programmed, acknowledgement tones cannot be switched off.

When a valid or invalid transponder key or transponder card is recognised, the transponder reader generates an acknowledgement tone.

This acknowledgement tone is activated/deactivated as follows:

1. Hold the **programming card 9 seconds** in front of the transponder reader until the third acknowledgement tone is heard.
after 3 and 6 seconds an acknowledgement tone is heard. Please wait until the third acknowledgement tone.
- ✓ The LED flashes green once and then regularly flashes green three times.
2. Hold the **programming card** briefly in front of the transponder reader to switch the acknowledgement tone on/off:
 - ✓ 1 acknowledgement tone + green LED = acknowledgement tone on
 - 2 acknowledgement tones + red LED = acknowledgement tone off
3. Wait 10 seconds until the transponder reader automatically terminates the programming mode with three acknowledgement tones.

Setting range of far field

The nominal range of the far field of the transponder reader is 1.50 m. This range can be reduced if necessary to half.



Limited range in a metallic environment

The nominal range of the transponder reader is limited in metallic environments.

Use in energy profiles: approx. 0.9 m

Use in Profile 55: approx. 0.6 m

Use in letterbox system: approx. 0.35 m

The range of the far field is set as follows:

1. Hold the **programming card 12 seconds** in front of the transponder reader until the fourth acknowledgement tone is heard.
after 3, 6 and 9 seconds an acknowledgement tone is heard each time. Please wait until the fourth acknowledgement tone.
- ✓ The LED flashes green once and then regularly flashes green four times.
2. Hold the **programming card** briefly in front of the transponder reader to set the range:
 - ✓ 1 acknowledgement tone + green LED = maximum range
 - 2 acknowledgement tones + red LED = half range
3. Wait 10 seconds until the transponder reader automatically terminates the programming mode with three acknowledgement tones.

Reset to factory settings – delete all assignments

The transponder reader can be reset to the state of delivery. In this case, all assignments and settings are lost.

The factory setting is carried out as follows:

1. Hold the **the programming card 3 seconds** in front of the transponder reader until an acknowledgement tone is generated.
 - ✓ A further acknowledgement tone follows, the LED flashes green once and then lights up orange.
2. Hold the **transponder card 3 times for 3 seconds** in front of the transponder reader with a pause of 1 second each time:
 - ✓ 1st time → 1 acknowledgement tone - LED flashes orange once,
 - 2nd time → 1 acknowledgement tone - LED flashes orange twice,
 - 3rd time → 1 acknowledgement tone - LED lights up orange.
- ✓ The LED flashes green.

The transponder reader is now in state of delivery again. Assignments to the programming card and all transponder keys and transponder cards are deleted.



Important! **Programming card also deleted**

Before reprogramming, the programming card must first be assigned.

Integration in the door communication system



Before start-up, assign programming card and transponder key.

Before start-up the transponder reader in the door communication system, the programming card and the corresponding transponder keys must be assigned (from Page 17).

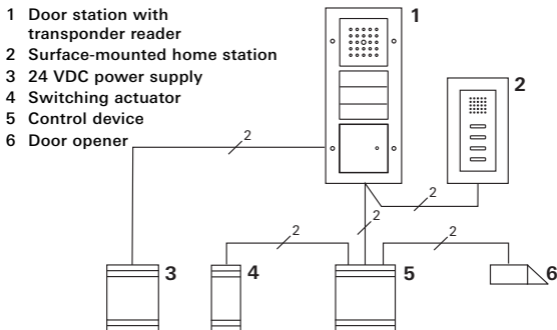

The transponder reader can be connected to the Gira flush-mounted door stations and to the built-in loudspeaker. Via previously taught-in transponder keys, up to 16 switching actuators (8 group actuators + 8 individual switching actuators) and the door opener function can be controlled.

Full functionality of the switching actuators from Index I02.

Connection to door communication system

The transponder reader is connected to a door communication bus coupler or call button insert of the Gira door communication system with the accompanying connection cable.

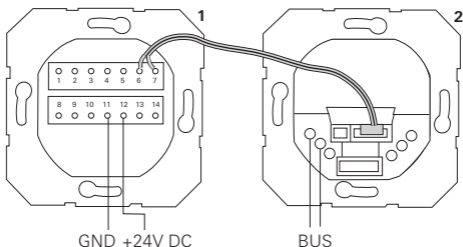

- 1 Transponder reader
- 2 Door communication bus coupler

In operation with the door communication system, the transponder reader must be operated with an additional power supply. Power supply for the transponder reader is not possible via the door communication bus.



First, start up the door communication system

Before programming of the transponder reader is begun, the door communication system must be started up.

V

Direct assignment/group assignment

Assignment differentiates between:

- **direct assignment** of individual transponder keys (or transponder cards) to an individual switching actuator
- **group assignment** of all transponder keys (or transponder cards) to a switching actuator.

With group assignments, all transponder keys (or transponder cards) assigned to the transponder reader trigger a switching action with the switching actuator.

during programming, instead of a transponder key the programming card is held in front of the transponder reader.



Advantage of group assignment

With group assignments, all taught-in transponder keys and cards in a programming step are assigned a common switching actuator.

Transponder keys and cards that are assigned at a later date to the transponder reader can switch this common switching actuator without further programming.

Assigning transponder key with far field function to a switching actuator/door opener

Before assignment, the programming card and all transponder keys/cards of the transponder reader must be assigned, see from Page 17.

1. Press the "Systemprogr." button on the control device for 3 sec. to start programming mode.
 - ✓ The LED at the control device flashes.
The transponder reader generates an acknowledgement tone and the LED flashes orange.
The operating mode LED of the switching actuator flashes.
2. Press the button "Progr." at the switching actuator (or the button "Türöffnerprogr." of the control device), until the LED next to the button flashes.
 - ✓ The transponder reader generates an acknowledgement tone.
3. Hold the assigned transponder key once in front of the transponder reader until an acknowledgement tone is generated and the LED flashes green.
 - ✓ The transponder reader and the door station generate one acknowledgement tone each.
 - ✓ The transponder key is assigned to the transponder reader and switches the switching actuator in the far field.
 - ✓ Further transponder keys can now be assigned.

4. Press the "Systemprogr." button on the control device to exit the programming mode.



Assign transponder card

The transponder card switches the switching actuator in the near field. The transponder card is assigned as described above.



Group assignment

If a group of transponder keys/cards should be assigned, the programming card must be held in front of the transponder reader instead of the transponder key.

Assigning transponder key with near field function to a switching actuator/door opener

Before assignment, the programming card and all transponder keys/cards of the transponder reader must be assigned, see from Page 17.

1. Press the "Systemprogr." button on the control device for 3 sec. to start programming mode.
 - ✓ The LED at the control device flashes.
The transponder reader generates an acknowledgement tone and the LED flashes orange.
The operating mode LED of the switching actuator flashes.
2. Press the button "Progr." at the switching actuator (or the button "Türöffnerprogr." of the control device), until the LED next to the button flashes.
 - ✓ The transponder reader again generates an acknowledgement tone.
3. Hold the transponder key to be assigned 2 times with a pause of 1 second in front of the transponder reader:
 - ✓ 1st time → 1 acknowledgement tone - LED flashes green.
 - 2nd time → 2 acknowledgement tones - LED flashes green twice.
4. The transponder key is assigned to the transponder reader and switches the switching actuator in the near field.
 - ✓ Further transponder keys can now be assigned.

5. Press the "Systemprogr." button on the control device to exit the programming mode.



Assign transponder card

The transponder card switches the switching actuator in the near field. The transponder card is assigned as described above.



Group assignment

If a group of transponder keys/cards should be assigned, the programming card must be held in front of the transponder reader instead of the transponder key.

Assigning transponder key with near and far field function to a switching actuator/door opener

Before assignment, the programming card and all transponder keys/cards of the transponder reader must be assigned, see from Page 17.

1. Press the "Systemprogr." button on the control device for 3 sec. to start programming mode.
 - ✓ The LED at the control device flashes.
The transponder reader generates an acknowledgement tone and the LED flashes orange.
The operating mode LED of the switching actuator flashes.
2. Press the button "Progr." at the switching actuator (or the button "Türöffnerprogr." of the control device), until the LED next to the button flashes.
 - ✓ The transponder reader again generates an acknowledgement tone.
3. Hold the transponder key to be assigned 3 times with a pause of 1 second each time in front of the transponder reader:
 - ✓ 1st time → 1 acknowledgement tone - LED flashes green once.
 - 2nd time → 2 acknowledgement tones - LED flashes green twice.
 - 3rd time → 3 acknowledgement tones - LED flashes green three times.
 - ✓ The transponder key is assigned to the transponder reader and switches the switching actuator in the near and far field.

- ✓ Further transponder keys can now be assigned.
4. Press the "Systemprogr." button on the control device to exit the programming mode.



Assign transponder card

The transponder card switches the switching actuator in the near field. The transponder card is assigned as described above.



Group assignment

If a group of transponder keys/cards should be assigned, the programming card must be held in front of the transponder reader instead of the transponder key.

Deleting assignment of transponder key - switching actuator/door opener

1. Press the "Systemprogr." button on the control device for 3 sec. to start programming mode.
 - ✓ The LED at the control device flashes.
The transponder reader generates an acknowledgement tone and the LED flashes orange.
The operating mode LED of the switching actuator flashes.
2. Press the button "Progr." at the switching actuator (or the button "Türöffnerprogr." of the control device), until the LED next to the button flashes.
 - ✓ The transponder reader again generates an acknowledgement tone.
3. Hold the transponder key to be deleted 4 times with a pause of 1 second each time in front of the transponder reader:
 - ✓ 1st time → 1 acknowledgement tone - LED flashes green once,
 - 2nd time → 2 acknowledgement tones - LED flashes green twice,
 - 3rd time → 3 acknowledgement tones - LED flashes green three times,
 - 4th time → 4 acknowledgement tones - LED flashes green four times.
 - ✓ The transponder key is deleted.
 - ✓ Further transponder keys can be deleted.
4. Press the "Systemprogr." button on the control device to exit the programming mode.



Delete transponder card

A transponder card is deleted as described above.



Delete group assignment

If a group of transponder keys/cards are to be deleted, the programming card must be held in front of the transponder reader instead of the transponder key.

Relays / actuators – what switches when?

The following rules apply with the basic configuration of the switching actuator assignments:

- the relays of the transponder reader are not switched as soon as a switching actuator is assigned.
- an individual switching actuator always has a higher priority than a group switching actuator.

Individual actuator	Group actuator	Relay
not assigned	not assigned	switches
not assigned	assigned - switches	does not switch
assigned - switches	assigned – does not switch	does not switch

Extended configuration

In the basic configuration a transponder key (or transponder card) switches only the assigned switching actuator. If this transponder key additionally triggers a "group actuator" or a relay, the transponder key (or transponder card) is assigned a special mode:

Mode	Assigned individual actuator	Assigned group actuator	Assigned relay
1*	switches	does not switch	does not switch
2	switches	switches	does not switch
3	switches	does not switch	switches
4	switches	switches	switches

* Factory setting

5 rules for selecting the correct mode

Rule 1:

If the door communication system has not been assigned any switching actuators, the relays assigned to the transponder key* are always switched.

Rule 2:

If the relays should switch together with a switching actuator (individual/group), mode 3 or 4 must be selected.

Rule 3:

An individual switching actuator assigned to an individual transponder key* always has a higher priority than a group switching actuator.

Rule 4:

If a group switching actuator is assigned, it switches in mode 1 as long as no individual switching actuator is assigned.

Rule 5:

If a group switching actuator should switch together with an individual switching actuator, mode 2 or 4 must be selected.

*or transponder card

Assigning mode to a transponder key

To assign the corresponding mode to a transponder key, proceed as follows:

1. Press the "Systemprogr." button on the control device for 3 sec. to start programming mode.
 - ✓ The LED at the control device flashes.
The transponder reader generates an acknowledgement tone and the LED flashes orange.
2. When the transponder key is briefly held in front, the corresponding mode can be selected:
 - ✓ With the first holding of the transponder key in front, the current active mode is displayed with acknowledgement tones and flashing of the green LED.

Mode	Indiv. actuator	Group actuator	Relay	Tones	LED
1	YES	NO	NO	1	1-gang
2	YES	YES	NO	2	2-gang
3	YES	NO	YES	3	3-gang
4	YES	YES	YES	4	4-gang

3. With a repeated brief holding of the transponder key in front, the transponder reader changes to the next mode.
4. Repeat step 3 until the desired mode is reached.
5. Press the "Systemprogr." button on the control device to exit the programming mode.

Changing mode of a key group

To assign the corresponding mode to a group of keys, proceed as follows:

1. Press the "Systemprogr." button on the control device for 3 sec. to start programming mode.
 - ✓ The LED at the control device flashes.
The transponder reader generates an acknowledgement tone and the LED flashes orange.
2. When the programming card is briefly held in front, the corresponding mode can be selected:
 - ✓ With the first holding of the programming card in front, the current active mode is displayed with acknowledgement tones and flashing of the green LED.

Mode	Indiv. actuator	Group actuator	Relay	Tones	LED
1	YES	NO	NO	1	1-gang
2	YES	YES	NO	2	2-gang
3	YES	NO	YES	3	3-gang
4	YES	YES	YES	4	4-gang

3. With a repeated brief holding of the programming card in front, the transponder reader changes to the next mode.
4. Repeat step 3 until the desired mode is reached.
5. Press the "Systemprogr." button on the control device to exit the programming mode.

Example 1: Starting up stand-alone function

In this example, relay 1 of the transponder reader switches the door opener.

The door opener function should be triggered as soon as the assigned transponder key moves within the detection range (far field) of the transponder reader.

Switching

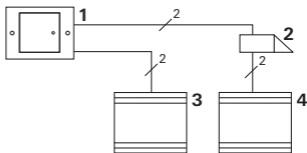

- 1 Transponder reader
- 2 Door opener
- 3 Power supply
24 V DC
- 4 Power supply
of door opener



Door opener with separate power supply

A door opener connected at the relays of the transponder reader should be connected to a separate power supply.

Start-up

1. Before first start-up the programming card must be assigned to the transponder reader:
For this, hold the programming card 3 seconds in front of the transponder reader.
2. In programming mode, assign the transponder key to relay 1:
For this, hold the transponder key 1 second in front of the transponder reader.

Operation

To open the door, the person with the transponder key must enter the detection range of the transponder reader.

Example 2: Starting up door communication system

In the single-family house, all occupants should be able to open the door with their transponder keys (group assignment).

Selected persons should be able to switch on the outside light via the near field function.

Switching

- 1 Door station with transponder reader
- 2 Surface-mounted home station
- 3 24 VDC power supply
- 4 Switching actuator
- 5 Control device
- 6 Door opener

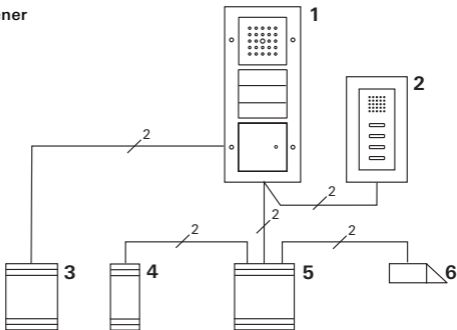

Start-up

1. Before first start-up the programming card must be assigned to the transponder reader:
For this, hold the programming card 3 seconds in front of the transponder reader.
2. All transponder keys must first be assigned to the transponder reader:
For this, hold all transponder keys 1 second each in front of the transponder reader in programming mode.

Assigning the switching actuator

1. Start programming mode at the control device.
2. Start the programming mode at the switching actuator and select the operating mode "Switching".
3. In programming mode, assign a transponder key to the switching actuator:
For this, hold the selected transponder key two times for 1 second in front of the transponder reader.
4. Exit programming mode at the control device.

Assigning the door opener

All house occupants should be able to open the door with their transponder keys in the far field.

1. Start programming mode at the control device.
2. Start door opener programming mode at the control device.
3. Carry out the group assignment with the programming card:
For this, hold the programming card for 1 second in front of the transponder reader.
4. Exit programming mode at the control device.

Operation

To switch on the light:

Hold the selected transponder key directly in front of the transponder reader (immediate area).

To open the door, the person with the transponder key must enter the detection range of the transponder reader.

Example 3: Integration in door communication system without speech function

If no speech function is required, the transponder reader can be integrated into the door communication system as follows:

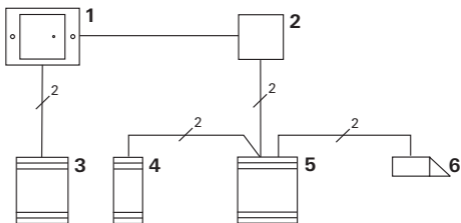

- 1 Transponder reader
- 2 Bus coupler
Door communication
- 3 24 V DC power supply
- 4 Switching actuator
- 5 Control device
- 6 Door opener



Pay attention before start-up!

Before start-up the bus coupler must be assigned to the control device. For this, a jumper is attached between the ET terminals for 3 seconds in system programming mode.

Activation input

With a blank activation input the relay is switched as soon as an authorised transponder key or transponder card moves within the detection range of the transponder reader.

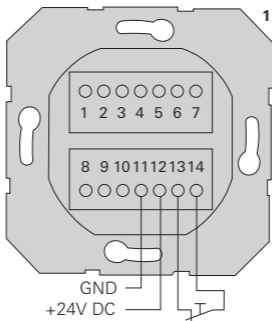

If a push button (NC contact) is connected to GND at activation input, the transponder reader first searches for authorised transponder keys after activation (via opening of the contact).

Relay of transponder reader

The transponder reader is equipped with 2 zero-voltage two-way switch relays (load: 24 V / 1.6 A AC/DC), controlled by the transponders in different ways:

Relay 1:

- via the transponder key in the far field
- via the transponder key in the near field (in emergency mode, when the battery is drained, hold-up time > 3 secs.)
- via the transponder card in the near field

Relay 2:

- via the transponder key in the near field
- via the transponder card in the near field

Due to the differentiation between near field and far field it is therefore possible to trigger two varying switching actions with one transponder key, e.g.

far field = activation of door opener,

near field = switch on outside light (via impulse relay).

Or in conjunction with a motor lock:

far field = opening of door,

near field = locking of door.

Changing battery of transponder key

The transponder key is powered by a lithium round cell (CR 2032). The battery of the transponder key has a service life of approx. 3 years.

For replacing the round cell the transponder key can be opened without tools:

1. hold the top housing section of the transponder key and pull away the lower housing section with a twisting movement. A certain amount of effort is necessary as the sections are sealed with a rubber ring.
 2. The round cell is situated below the bracket contact and can now be removed.
- ✓ When replacing the battery take care that this is pushed into the retainer with the correct polarisation. Correct polarisation is shown with a stamped "+" upon the retainer.
3. Refit the lower housing section into the upper housing section. The recess for the inscription space indicates correct positioning.

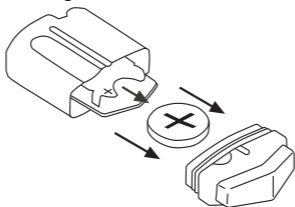

Storing of transponder keys

The permanent storage of transponder keys (for example on key hooks) within the detection range should be avoided. Firstly the battery will be drained considerably faster than in normal operation. And secondly a transponder key kept within the detection range can sporadically “wake up”, send an answer to the transponder reader and consequently trigger an action (e.g. opening of the door).

In order to avoid this, transponder keys should be stored away from the detection range of the transponder reader. Please note the following:

- without metallic influence the transponder key should be kept > 2.5 m away from the transponder reader.
- with metallic influence (e.g. continuous metal framing, sheet metal coverings), the transponder key should be kept > 3 m away and should not be in direct contact with metallic elements.

Procedure with loss of programming card

With loss of the programming card the transponder reader cannot be configured anymore. In this case the transponder reader along with the accompanying security card should be sent to the Gira Service Center. A resetting to factory settings is carried out there, meaning all assignments are deleted. You subsequently receive the transponder reader again with a new programming card.

Freischaltcode

F8 FA 41 58 B2 3D 03 F8
94 48 45 82 B2 74 E3 3D



Gira Keyless In
Safety Card
Transponder

GIRA

Behaviour with excess temperature

For protection of the electronics, the key evaluation function of the transponder reader is slowed above 55 °C . When the excess temperature value is met (60 °C), the reading function of the electronics is temporarily stopped.

In this condition the LED flashes regularly every 10 seconds orange. When the temperature drops, normal operation mode is automatically restored.

Technical data

Power supply:	24 V DC \pm 10 %, 300 mA
Protection type:	IP 20 (system 55) IP 44 (TX_44)
Temperature range:	-20 °C to +55 °C
Resistance to EMD:	up to 8 kV
Relay load capacity:	24 V / 1.6 A AC/DC



Relay protection with free-wheeling diode

For protection of relay contacts it is recommended to parallel connect a free-wheeling diode when connecting inductive loads (e.g. door openers).

Transponder key

Battery:	Lithium round cell CR 2032
Protection type:	IP 54

Warranty

The warranty is provided in accordance with statutory requirements via the specialist trade.

Please submit or send faulty devices postage paid together with an error description to your responsible salesperson (specialist trade/installation company/electrical specialist trade).

They will forward the devices to the Gira Service Center.

Giersiepen GmbH & Co. KG
Electrical Installation
Systems
P.O. Box 12 20
42461 Radevormwald
Germany
Phone +49 (0) 21 95 / 602 - 0
Fax +49 (0) 21 95 / 602 - 191
www.gira.com
info@gira.com

41 09 94 12/12

GIRA