

Issue:
18.10.2011

Blind actuator 4-gang 24 V DC Order-No. 2154 00



Contents

1	Product definition	3
1.1	Product catalogue	3
1.2	Function	3
2	Installation, electrical connection and operation	4
2.1	Safety instructions	4
2.2	Device components	5
2.3	Fitting and electrical connection	6
2.4	Commissioning	9
2.5	Operation	11
3	Technical data	14
4	Software description	15
4.1	Software specification	15
4.2	Software "Venetian blind 20C7x1"	16
4.2.1	Scope of functions	16
4.2.2	Notes on software	17
4.2.3	Object table	18
4.2.4	Functional description	24
4.2.4.1	Description of channel-independent functions	24
4.2.4.2	Channel-oriented functional description	31
4.2.4.3	Delivery state	86
4.2.5	Parameters	87
5	Appendix	124
5.1	Index	124

1 Product definition

1.1 Product catalogue

Product name: Shutter/blind actuator 4fold 12-48 V DC DRA

Use: Actuator

Design: Rail-mounted device (REG)

Order-No. 2154 00

1.2 Function

The Venetian blind actuator receives telegrams from sensors or other controllers using the KNX/EIB and, together with the independent relay contacts, it switches electrically-powered Venetian blinds, roller shutters, awnings, venting louvres or similar blinds for low voltage 12...48 V DC. Each output is equipped with externally supplied monostable switching relays so that the preferred contact positions are maintained also during bus voltage failure.

The controls (4 pushbuttons) on the front panel of the device permit switching the relays on and off by hand in parallel with the KNX / EIB even without bus voltage or in a non-programmed state. This feature permits fast checking of connected motors for proper functioning.

The functionalities that can be preset with the ETS independently for each output channel include, for instance, separately parameterizable moving times, enlarged feedback functions, assignment to up to five different safety functions, a sun protection function adapted to a great variety of requirements and the incorporation into scenes or forced-position applications. Centralised control of all outputs is also possible. Moreover, the preferred states of the relay contacts in case of bus voltage failure or bus and supply voltage return and after ETS programming can be preset separately.

For project design and commissioning of this device, we recommend using the ETS3.0 from Version d patch A. The advantages with regard to downloading (shorter loading times) are available only if this ETS version or later versions are used. For ETS2 and older versions of ETS3, a separate product database is available.

The device electronics of the blinds actuator are supplied via the connection of the DC supply voltage of outputs 1 and 2 (terminals "+ U1/2 -"). For actuation of all outputs, the external DC supply must always be switched on. The integrated bus coupler is supplied from the bus voltage or the external supply voltage, meaning that the device can only be programmed using the ETS when the KNX/EIB bus voltage is switched on.

The device is designed for mounting on DIN rails in closed compact boxes or in power distributors in fixed installations in dry rooms.

2 Installation, electrical connection and operation

2.1 Safety instructions

Electrical equipment may only be installed and fitted by electrically skilled persons. The applicable accident prevention regulations must be observed.

Failure to observe the instructions may cause damage to the device and result in fire and other hazards.

Before working on the device or exchanging the connected loads, disconnect it from the power supply (switch off the miniature circuit breaker), otherwise there is the risk of an electric shock.

The blind actuator is not suited for safe disconnection of the mains.

For parallel connection of several drives to an output it is indispensable to observe the corresponding instructions of the manufacturers. There is otherwise risk of irreparable damage to the drives.

Use only curtains with mechanical or electronic limit switches. Check the limit switches for correct adjustment.

Make sure during the installation that there is always sufficient insulation between the mains voltage and the bus. A minimum distance of at least 4 mm must be maintained between bus conductors and mains voltage cores.

The device may not be opened or operated outside the technical specifications.

2.2 Device components

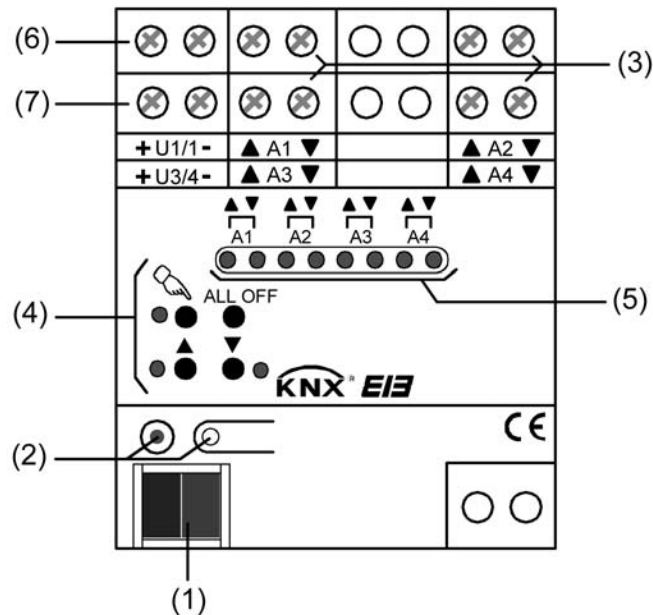

Figure 1: Device components

- (1) KNX/EIB bus connection
- (2) Programming button and programming LED (red). The programming LED flashes slowly when the safe-state mode is active.
- (3) Screw terminal for connection of the DC motors.
- (4) Button field for manual control
- (5) Status LED of the outputs with direction display (2 LEDs for each output):
 LED off: output switched off
 LED on: Output switched on (movement up " ▲ " or movement down " ▼ ")
 LED flashing slowly: output in manual control
 LED flashing quickly: output blocked by manual control
- (6) Terminal connection for external DC power supply of the outputs 1 and 2 and of the device electronic
- (7) Terminal connection for external DC power supply of the outputs 3 and 4

Dimensions:

Width (W): 72 mm (4 modules) / height (H): 90 mm / depth (D): 70 mm

2.3 Fitting and electrical connection



DANGER!

Electrical shock when live parts are touched.

Electrical shocks can be fatal.

Before working on the device, disconnect the power supply and cover up live parts in the working environment.





CAUTION!

Danger of destruction if several drives are connected in parallel to one output.

Limit switch contacts can weld together and drives, curtains and the shutter actuator can be destroyed.

Observe the manufacturer's instructions and use cutoff relays, if necessary.

Fitting the device

- Fit the device by snapping it onto a mounting rail in acc. with DIN EN 60715. The screw terminals should be at the top.
-  A KNX/EIB data rail is not required.
-  Observe the temperature range (-5 °C ...+45 °C) and ensure sufficient cooling, if necessary.

Connecting the power supply and the motor load

- Make the bus connection, connection of the supply voltage and of the drive motors in accordance with connection illustration (Figure 2).

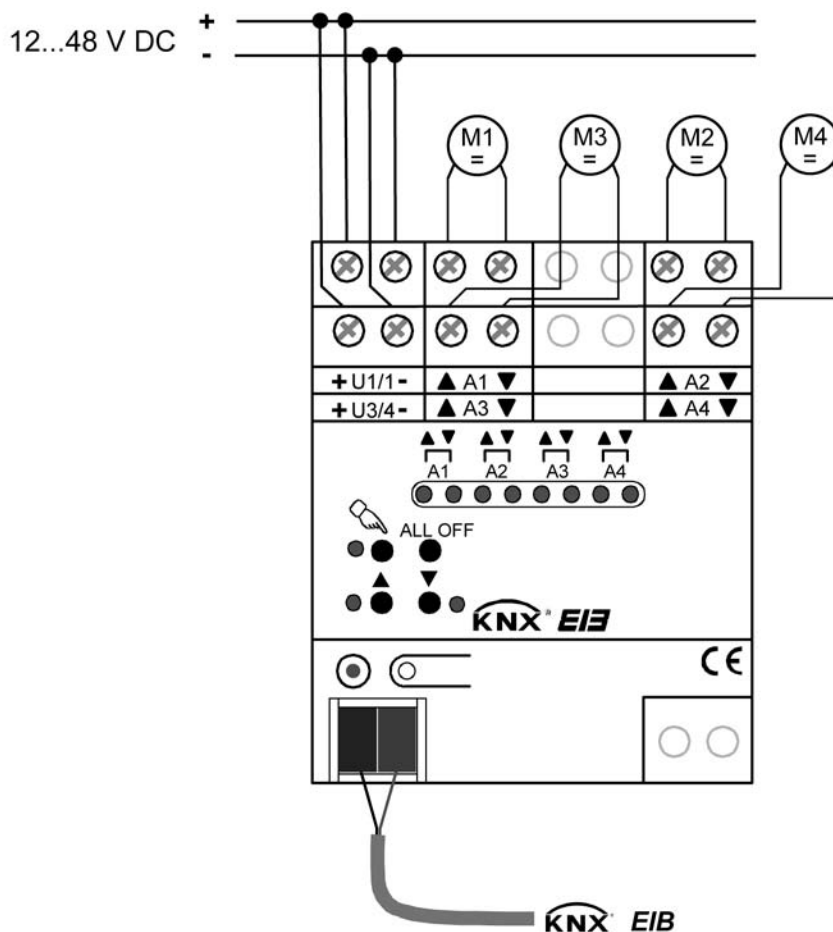

Figure 2: Electrical connection

The blinds actuator reverses the polarity of the voltage on the connected DC drive motors depending on the direction of motion being activated (polarity reversal switching). In the "stop" state, output "DOWN" is merely connected to negative voltage potential, which causes the drive motor to stop (Figure 3).

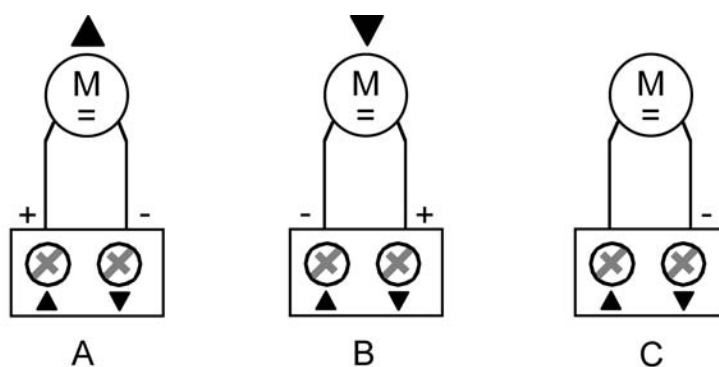

Figure 3: Polarity on the drive motors depending on the travel direction (A and B) and with the drive stopped (C).

- i** The device electronics of the blinds actuator and of outputs 1 and 2 are supplied via terminals "+ U1/2 -". For actuation of all outputs, the external DC supply must always be switched on. When outputs 3 and 4 are used, an additional DC supply voltage must be connected to terminals "+ U3/4 -".
The integrated bus coupler is supplied from the bus voltage or the external supply voltage, meaning that the device can only be programmed using the ETS when the KNX/EIB bus voltage is switched on.
The actuator has reversed voltage protection on the external supply voltage terminals. The polarity of the external voltages must be the same! Otherwise the actuator may be destroyed!
- i** The external DC power source must be designed so that it supplies a reliable operating voltage under all load conditions (especially when the motors are switched on), taking into account the maximum tolerance in accordance with the technical specification (cf. "Technical data"). Do not connect any AC power supplies!
- i** Observe the admissible motor load ratings (cf. 'Technical data').
- i** Venting louvers or windows must be connected in such a way that they open in travel direction "UP - ▲" and close in travel direction "DOWN - ▼".

Installing / removing the protective cap

To protect the bus lines against hazardous voltages, especially in the area of the connecting terminals, a protective cap can be installed.

The cap is installed with the bus terminal in place and the connected bus line led out at the rear.

- To install the cap: slide the cap over the bus connecting terminal until you feel it engage (Figure 4).
- To remove the cap: Remove the cap by pressing the sides slightly and by pulling it out to the front (Figure 4).

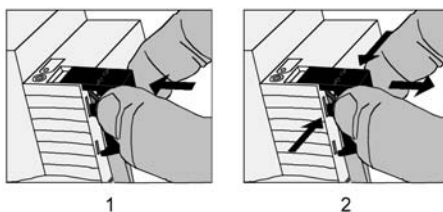

Figure 4: Installing / removing the protective cap for the bus connection

2.4 Commissioning

After installation of the actuator and connection of the bus line, the power supply and of all electrical drives, the device can be put into operation. The following procedure is generally recommended...



DANGER!

Electrical shock when live parts are touched.

Electrical shocks can be fatal.

Before working on the device, disconnect the power supply and cover up live parts in the working environment.

Measuring the travelling times

For the purpose of positioning blinds, shutters and awnings or for adjusting the opening angle of venting louvers, the actuator needs accurate information about the maximum travelling time.

Switch on external supply voltage.

- If not yet done, move the blind/shutter into the upper end position (open venting louver completely).
The upper limit-stop position is reached (venting louver opened).
- Start the measuring time and move the blind/shutter by manual control into the lower end position (close the venting louver completely).
- Stop the time measurement when the lower limit (when the completely closed) position is reached.
- Enter the measured value in the ETS (cf. "software description").

i It is wise to perform several time measurements and to take the average of these values.

i The travelling time can also be determined after commissioning with the ETS (bus operation).

Measuring the travelling time extension

When travelling upwards, blinds or shutters have a tendency of moving more slowly due to their own weight or to external physical influences (e.g. temperature, wind, etc.). The same applies to venting louvers where opening may take longer than closing.

For this reason, the shutter actuator takes the parameterized travelling time extension into account when moving upwards or when opening the louvers (MOVE operation / positioning).

The extension is computed as a percentage of the difference of the travelling times in both directions.

The blind/shutter (venting louver) must be in the lower end position (venting louver closed). Switch on supply voltage.

- If not yet done, move the blind/shutter into the lower end position (close venting louver completely)
Lower end position reached (venting louver closed).
- Start the measuring time and move the blind/shutter by manual control into the upper end position (open the venting louver completely).
- Stop the time measurement when the upper limit (the completely open) position is reached.
- Express the measured value as a percentage of the determined blind/shutter travelling time and enter the value in the ETS (cf. software description).

i It is wise to perform several time measurements and to take the average of these values.

i The travelling time extension can also be determined after commissioning with the ETS (bus operation).

Measuring the slat moving time (only for blinds)

In the case of blinds with slats, the slat moving time is for technical reasons part of the overall travelling time of the blind. The slat moving time is the time required for a movement between the slat positions "closed – 100 %" and "open – 0 %". In order to compute the opening angle of the slats, the actuator needs an information about the slat moving time.

The slats must be completely closed (as in case of downward travel of the blind).

Switch on supply voltage.

- Start the measuring time and open the slats completely by manual control (as in case of upward travel of the blind).
 - Take the measuring time when the completely open position is reached.
 - Enter the measured value in the ETS (cf. "software description").
- i** It is wise to perform several time measurements and to take the average of these values.
- i** The slat moving time can also be determined after commissioning with the ETS (bus operation).

Commissioning with the ETS

- Switch on the bus voltage
Check: When the programming button is pressed, the red programming LED must light up.
 - Download the physical address and the application data with the ETS.
- i** When the DC supply voltage is on, the outputs of the actuator can be switched manually even if there is no bus voltage or if the actuator is not yet programmed. Due to this feature, the drives connected to the individual outputs can be checked for proper functioning already during site operation.

Performing a reference movement (optional)

The shutter actuator can approach predefined blind/shutter or louver positions only if the current positions are known. For this purpose, each output must be given the opportunity to synchronise itself whenever the supply voltage is switched on or after every ETS programming operation (physical address, application program, partial download). This synchronisation is performed by means of the reference movement.

Switch on supply voltage.

- If not yet done, move the curtains to the upper end position (open venting louver completely).
 - Wait until the output relay has switched off (not only the limit switch of the drive).
The reference movement is terminated.
- i** The shutter actuator stores the blind/shutter, slat or louver positions temporarily. After each supply voltage failure (failure of the bus voltage and of the external supply voltage) or after programming with the ETS, the actuator therefore automatically performs a reference travel for each output before a new position can be approached.
- i** After bus voltage return, the shutter actuator generates an "invalid position" message for each output which can also be transmitted to the bus, if so parameterized. The message is withdrawn (inverted signal value) as soon as a reference movement could be executed.

2.5 Operation

All outputs of the shutter actuator can also be operated manually. The button field with 4 function keys and 3 status LEDs on the front panel of the device can be used for setting the following modes of operation...

- Bus control: operation from touch sensors or other bus devices
 - Temporary manual control: manual control locally with keypad, automatic return to bus control,
 - Permanent manual control: local manual control with keypad.
- i** The operating modes can be enabled or disabled by parameter settings in the ETS.
- i** When manual control is active, the outputs cannot be controlled via the bus.
- i** Manual control is possible only while the actuator is supplied with power from the external supply voltage. The manual control mode ends in case of bus voltage return or external supply voltage failure.
- i** In manual mode, bus operation can be disabled via a telegram. Manual control is terminated on activation of the disabling function.
- i** Further details concerning the manual mode, especially with respect to the possible parameter settings and the interaction with other functions of the shutter actuator can be found in chapter "Software description" of the present documentation.

Controls and indicators for manual control

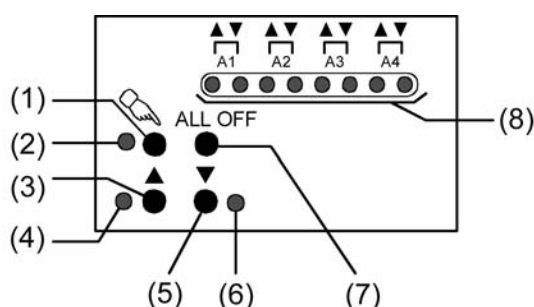

Figure 5: Controls and indicators for manual control on the front panel of the device.

- (1) Key : Activation / deactivation of manual control
- (2) LED : indicates permanent manual control.
- (3) Key : Sustained press: upward travel output (long-time operation) / brief press: output stop.
- (4) Status LED : indicates an active travel movement in the manual mode (up / open).
- (5) Key : Sustained press: downward travel output (long-time operation)/ brief press: output stop.
- (6) Status LED : indicates an active travel movement in the manual mode (down / close).
- (7) Key ALL OFF stop all drives (only in permanent manual control).
- (8) Status LEDs : indicate the state of the individual outputs. One of the LEDs is lit up during an active travel movement in the corresponding direction initiated by bus or by manual control. One of the LEDs flashes when the corresponding output has been selected in manual control. One of the LEDs flashes fast when the corresponding output has been disabled during manual control.

Priorities

The blind actuator distinguishes between different functions that can be active at an output. In order to prevent conflicting output states, each available function has a certain priority. The function with the higher priority overrides the function with the lower priority.

- 1st priority: manual control (highest priority),
- 2nd priority: forced position,
- 3rd priority: safety function(s),

Priority levels 4 and 5 can be parameterized in the ETS. The options are then

- 4th priority: sun protection function
- 5th priority: direct operation via the bus (short-time/long-time operation, positioning, scenes, central function),

or...



- 4th priority: direct operation via the bus (short-time/long-time operation, positioning, scenes, central function),
- 5th priority: sun protection function

or...

- 4th priority: sun protection function and direct operation via the bus (short-time/long-time operation, positioning, scenes, central function).

Switching on the temporary manual control

Manual control is enabled in the ETS.

- Press the  key briefly (< 1 s).
The two status LEDs of A1 are flashing (LED  remains off)

 After 5 s without a key-press, the actuator returns automatically to bus operation.

Deactivating temporary manual control

Temporary manual control was activated.

- No key-press for 5 s

- or -

- Select all outputs one after another by a brief press of the key. Thereafter, press the key once again.



- or -

- Switch the DC power supply off or reset the bus (bus voltage return). Temporary manual control is terminated. The status LEDs A1...A4 indicate the status according to bus operation if the external supply voltage is on.

 The state set via manual control is not changed when temporary manual control is switched off. If, however, a function with a priority higher than that of the direct operation (e.g. forced position or safety function) has been activated via the bus before or during manual control, the actuator executes the function with the higher priority for the outputs concerned.

Switching on permanent manual control

Manual control is enabled in the ETS. Bus operation or temporary manual control is active.

- Press the  button for at least 5 s.
The status LED  is illuminated. The two status LEDs of A1 are flashing. Permanent manual control is active:

Deactivating permanent manual control

Permanent manual control is active.

- Press the  key for at least 5 s.

- or -

- Select all outputs one after another by a brief press of the key. Thereafter, press the key once again.

- or -

- Switch the DC power supply off or reset the bus (bus voltage return). The status LED  goes out. The status LEDs A1...A4 indicate the status according to bus operation if the external supply voltage is on.

 Depending on the configuration of the actuator in the ETS, the outputs will be set to the state last adjusted in the manual mode or to the state internally tracked (direct operation, forced position, safety or sun protection position) when the permanent manual mode is shut off.

Controlling an output manually

Manual control (permanent or temporary) is activated.

- Select the desired output: Press the  key briefly (if necessary, repeatedly).
LEDs of the selected output A1...A4 flash. If the selected output is active controlling a travel movement, the "▲" or "▼" status LEDs on the keypad are lit up additionally.
- Operate the output by pressing the ▲ button or ▼ button.
Short: Stop drive.
Long: Move drive up/down (long time operation) or open/close venting louvre.
The selected drive motor executes the corresponding commands immediately.

Shutting off all outputs (stopping all drives)

Permanent manual control is active:

- Press the ALL OFF key
All outputs are shut off immediately (stop). The outputs are not locked. Individual activation is again possible after shutoff.

 The "ALL-OFF" function is not available in temporary manual control.

Disabling bus control of individual outputs manually

Permanent manual control is active:

Disabling of the bus control mode must have been enabled in the ETS.

- Select the output: Press the  key briefly (if necessary, repeatedly).
LEDs of the selected output A1...A4 flash. If the selected output is active controlling a drive movement, the "▲" or "▼" status LEDs on the keypad are lit up additionally.
- Press the ▲ and the ▼ key simultaneously for at least 5 s.
The appropriate output is locked (control via the bus not possible). The LEDs of the selected output A1...A4 flash fast.

 To unlock, proceed in the same way.

 An output that has been disabled in manual control can thereafter only be operated in permanent manual control.

3 Technical data

General

Mark of approval	KNX / EIB
Ambient temperature	-5 ... +45 °C
Storage/transport temperature	-25 ... +70 °C (Storage above +45 °C reduces the lifetime.)
Installation position	as desired (preferably top output terminals)
Minimum distances	none
Fixing type	Snapping onto top hat rails in closed housing (e.g. small distribution board, etc.)
Fitting width	72 mm / 4 modules

Terminals for mains supply and outputs

Connection mode	Screw terminal
Single stranded	0.5 ... 4 mm ²
finely stranded without conductor sleeve	0.34 ... 4 mm ²
finely stranded with conductor sleeve	0.14 ... 2.5 mm ²
Connection torque	max. 0.8 Nm

KNX/EIB supply

KNX medium	TP 1
Commissioning mode	S-mode
Rated voltage KNX	DC 21 ... 32 V SELV
Power consumption KNX	typical 150 mW
Connection mode KNX	Standard terminal

External supply

Rated voltage DC	DC 12 ... 48 V = (+10 % / -15 %)
Power consumption	max. 2.5 W
Power loss	max. 1 W

Outputs

Contact type	μ contact, monostable
Switching voltage DC	DC 12 ... 48 V
Contact rating DC 12/24 V	6 A
Switching current DC 48 V	3 A
Minimum DC switching current	100 mA
Blind/shutter travelling time	max. 20 min
Duty cycle	max. 50% (cycle time ≤ 40 min)

4 Software description

4.1 Software specification

ETS search paths: - shutter / shutter / Shutter/blind actuator 4fold 12-48 V DC DRA

BAU used: TPUART + μ C
 KNX/EIB type class: 3b device with cert. Physical layer + stack
 Configuration: S mode standard
 PEI type: "00"_{Hex} / "0"_{Dec}
 PEI connector: No connector

Applications:

No.	Short description	Name	Version	from mask version
1	Multi-functional shutter application with separately parameterizable travelling times; enlarged feedback functions, assignments to up to 5 different safety functions and a sun protection function adapted to the highest requirements. Also allows inclusion in scenes or forced movements. Centralised control of all outputs is also possible. Moreover, the preferred states of the relay contacts in case of bus voltage failure or bus and supply voltage return and after ETS programming can be preset separately.	Venetian blind 20C701	0.1 for ETS 2 and ETS 3.0a...c	705
2	Multi-functional shutter application with separately parameterizable travelling times; enlarged feedback functions, assignments to up to 5 different safety functions and a sun protection function adapted to the highest requirements. Also allows inclusion in scenes or forced movements. Centralised control of all outputs is also possible. Moreover, the preferred states of the relay contacts in case of bus voltage failure or bus and supply voltage return and after ETS programming can be preset separately.	Venetian blind 20C711	1.1 for ETS 3.0 version d and onwards patch A and onwards	705

4.2 Software "Venetian blind 20C7x1"

4.2.1 Scope of functions

General

- 4-channel operation for direct connection of four 12...48 V DC drive motors.
- Behaviour in case of bus voltage failure and bus voltage return as well as after ETS programming presettable for each output.
- Central control of all Venetian blind outputs via 1-bit long-time operation telegram possible.
- Active feedback telegrams can be globally delayed after bus voltage return.
- Manual control of outputs independent of the bus (for instance, building site operation) with LED status indicators.

Channel-oriented functions:

- Each output offers the full scope of functions without any restrictions. All channel-oriented functions can be parameterized separately for each output. This feature permits independent and multi-functional control of the shutter outputs.
- Mode of operation parameterizable: control of blinds with slats, shutters or venting louvers.
- Separately configurable blind travelling times with travelling time extension for moves into the upper end position.
- For blinds with slats, a slat moving time can be independently configured
- Travel direction change-over time and the times for short-time and long-time operation (step, move) presettable.
- Blind/shutter or slat position feedback telegram (only with bus control). In addition, an invalid blind position or an invalid travel movement can be reported back. Active (transmitting after changes) or passive (object readout) feedback functions.
- Assigning of outputs to up to 5 different safety functions (3 wind alarms, 1 rain alarm, 1 frost alarm) optionally with cyclical monitoring. The safety functions (objects, cycle times, priority) are programmed device-oriented and in common for all outputs. The assignment of individual outputs to the safety functions and the safety measures can be parameterized for each channel.
- An extensive sun protection function with fixed and variable blind or slat positions at the beginning and at the end of the function can be activated separately for each output. Dynamic slat offset for slatted blinds included. Also with extended sun protection feature for integration into sophisticated shading control programs (operated via separate automatic and disabling object). Optionally also with automatic heating/cooling and presence detection function.
- Forced-position function can be implemented for each shutter output.
- Integration into light-scenes possible: up to 8 internal scenes parameterizable per output

4.2.2 Notes on software

ETS project design and commissioning

For project design and commissioning of this device, we recommend using the ETS3.0 from Version d patch A. The advantages with regard to downloading (shorter loading times) are available only if this ETS version or later versions are used. The advantages are gained through the use of the new mask version 7.5.

The product database required for the ETS3.0d is offered in the *.VD4 format. The corresponding application program has the version number "1.1".

For the ETS2 and older versions of the ETS3 a separate product database in the *.VD2 format is available. The application program for these ETS versions is version number "0.1".

When older ETS versions are updated to the level of version ETS3.0d or to that of later versions, an additional tool in the form of an ETS3 add-in is available. This tool is able to convert older product databases with application version "0.1" – for example from existing ETS2 projects – into the new application format (version "1.1"). This way you can make use of the advantages of the ETS3.0d application easily and without changing the configuration. The ETS3 add-in can be obtained separately and free of charge from the manufacturer.

Safe-state mode

If the device does not work properly - for instance as a result of errors in the project design or during commissioning - the execution of the loaded application program can be halted by activating the safe-state mode. The safe-state mode does not permit controlling the outputs via the bus and by hand. The actuator remains passive since the application program is not being executed (state-of-execution: terminated). Only the system software is still functional so that the ETS diagnosis functions and also programming of the device continue to be possible.

Activating the safe-state mode

- Switch off bus voltage and external supply voltage.
- Press and hold down the programming button.
- Switch on bus voltage or supply voltage. Release the programming button only after the programming LED starts flashing slowly.

The safe-state mode is activated. With a new brief press of the programming button, the programming mode can be switched on and off as usual also in the safe-state mode. The programming LED will nevertheless continue to flash independently of the programming mode as long as the safe-state mode is active.

- i** The safe-state mode can be terminated by switching off the supply voltage or by programming with the ETS.

Unloading the application program

The application program can be unloaded with the ETS. In this case, manual control as part of the application program is not available either.

4.2.3 Object table

Number of communication objects:	84 (max. object number 107 - gaps in between)
Number of addresses (max):	254
Number of assignments (max):	255
Dynamic table management	No
Maximum table length	255

Channel-independent objects

Function: Manual operation

Object	Function	Name	Type	DPT	Flag
 ⁰	Disabling	Manual operation	1-bit	1,003	C, W, -, (R) ₁

Description 1-bit object for disabling the buttons for manual control on the device. The polarity can be configured.

Function: Manual operation

Object	Function	Name	Type	DPT	Flag
 ¹	Status	Manual operation	1-bit	1,002	C, -, T, (R) ₁

Description 1-bit object for manual control status transmission. The object is "0", when manual control is deactivated (bus control). The object is "1", when manual control is being activated. You can configure whether the temporary or the permanent manual control will be indicated as status information or not.

Function: Venetian blind central function

Object	Function	Name	Type	DPT	Flag
 ²	Central movement	All Venetian blind outputs	1-bit	1.008	C, W, -, (R) ₁

Description 1-bit object for central actuation (long-time movement) of assigned Venetian blind outputs. The polarity can be configured.

Function: Safety function

Object	Function	Name	Type	DPT	Flag
 ³	Wind alarm 1	Safety	1-bit	1.005	C, W, -, (R) ₁

Description 1-bit object for central activation or deactivation of the first wind alarm ("0" = wind alarm deactivated / "1" = wind alarm activated).

1: Each communication object can be read out. For reading, the R-flag must be set.

Function: Safety function

Object	Function	Name	Type	DPT	Flag
 4	Wind alarm 2	Safety	1-bit	1.005	C, W, -, (R) 1

Description 1-bit object for central activation or deactivation of the second wind alarm ("0" = wind alarm deactivated / "1" = wind alarm activated).

Function: Safety function

Object	Function	Name	Type	DPT	Flag
 5	Wind alarm 3	Safety	1-bit	1.005	C, W, -, (R) 1

Description 1-bit object for central activation or deactivation of the third wind alarm ("0" = wind alarm deactivated / "1" = wind alarm activated).

Function: Safety function

Object	Function	Name	Type	DPT	Flag
 6	Rain alarm	Safety	1-bit	1.005	C, W, -, (R) 1

Description 1-bit object for central activation or deactivation of the rain alarm ("0" = rain alarm deactivated / "1" = rain alarm activated).

Function: Safety function

Object	Function	Name	Type	DPT	Flag
 7	Frost alarm	Safety	1-bit	1.005	C, W, -, (R) 1

Description 1-bit object for central activation or deactivation of the frost alarm ("0" = frost alarm deactivated / "1" = frost alarm activated).

Channel-oriented objects:

Function: Long-time operation

Object	Function	Name	Type	DPT	Flag
 10, 36, 62, 88	Long-time operation	Output 1-4	1-bit	1,008	C, W, -, (R) 1

Description 1-bit object for activation of long time operation

Function: Short time operation

Object	Function	Name	Type	DPT	Flag
 11, 37, 63, 89	Short time operation	Output 1-4	1-bit	1,007	C, W, -, (R) 1

Description 1-bit object for activation of short time operation or for stopping a drive movement.

1: Each communication object can be read out. For reading, the R-flag must be set.

Function: Forced position

Object	Function	Name	Type	DPT	Flag
 12, 38, 64, 90	Forced position	Output 1-4	2-bit	2,008	C, W, -, (R) 1

Description 2-bit object for forced control of an output. The object state after bus voltage return can be predefined by means of a parameter.

Function: Light scene function

Object	Function	Name	Type	DPT	Flag
 13, 39, 65, 91	Scene extension	Output 1-4	1 byte	18,001	C, W, -, (R) 1

Description 1-byte object for recalling scenes or for storing new scene values.

Function: Sun protection function

Object	Function	Name	Type	DPT	Flag
 15, 41, 67, 93	Automatic mode	Output 1-4	1-bit	1,003	C, W, -, (R) 1

Description 1-bit object for activation or deactivation of the automatic sun protection in the extended sun protection mode ("1" = automatic mode activated / "0" = automatic mode deactivated). The object is only visible, if the automatic sun protection is to be tracked immediately when the state of the automatic object changes (parameter setting).

Function: Sun protection function

Object	Function	Name	Type	DPT	Flag
 16, 42, 68, 94	Automatic mode disable	Output 1-4	1-bit	1,003	C, W, -, (R) 1

Description 1-bit object for disabling of the automatic sun protection in the extended sun protection mode. The polarity can be configured. The object is only visible, if the automatic sun protection is to be tracked immediately when the state of the automatic object changes (parameter setting).

Function: Sun protection function

Object	Function	Name	Type	DPT	Flag
 16, 42, 68, 94	Automatic mode	Output 1-4	1-bit	1,003	C, W, -, (R) 1

Description 1-bit object for activation or deactivation of the automatic sun protection in the extended sun protection mode. The polarity can be configured. The object is only visible, if the automatic sun protection is to be tracked only when the state of the automatic object changes next time (parameter setting).

1: Each communication object can be read out. For reading, the R-flag must be set.

Function: Sun protection function

Object	Function	Name	Type	DPT	Flag
 17, 43, 69, 95	Direct operation disable	Output 1-4	1-bit	1,003	C, W, -, (R) 1

Description 1-bit object for disabling direct operation in the extended sun protection mode (direct operation = Move / Step / Position / Scene / Central). The polarity can be configured.

Function: Sun protection function

Object	Function	Name	Type	DPT	Flag
 18, 44, 70, 96	Sunshine / shading facade	Output 1-4	1-bit	1,002	C, W, -, (R) 1

Description 1-bit object for activation or deactivation of sun shading in the simple or extended sun protection mode (sun / no sun). The polarity can be configured.

Function: Sun protection function

Object	Function	Name	Type	DPT	Flag
 19, 45, 71, 97	Sunsh./shading position ²	Output 1-4	1 byte	5,001	C, W, -, (R) 1

Description 1-byte object for presetting a variable position value (0...255) for the height of the Venetian blind or roller shutter height or the venting louver position when the sun protection is active.

Function: Sun protection function

Object	Function	Name	Type	DPT	Flag
 20, 46, 72, 98	Slat pos. Sunshine / shading	Output 1-4	1 byte	5,001	C, W, -, (R) 1

Description 1-byte object for presetting a variable slat position value (0...255) when the sun protection is active.

Function: Sun protection function

Object	Function	Name	Type	DPT	Flag
 21, 47, 73, 99	Sunshine slat position offset	Output 1-4	1 byte	6,001	C, W, -, (R) 1

Description 1-byte object for presetting a slat position angle (- 100 % ... +100 % / smaller or larger position angles are treated as + or - 100 %) for 'manual' readjustment of the slat position during active sun protection.

1: Each communication object can be read out. For reading, the R-flag must be set.

2: The object designation varies with the type of blind (Venetian blind, roller shutter / awning, venting louver).

Function: Sun protection function – automatic heating/cooling

Object	Function	Name	Type	DPT	Flag
 22, 48, 74, 100	Heating/cooling presence	Output 1-4	1-bit	1,018	C, W, -, (R) ₁

Description 1-bit object for activation of the presence mode during automatic heating/cooling. The polarity can be configured. This object is generally linked with presence detectors.

Function: Sun protection function – automatic heating/cooling

Object	Function	Name	Type	DPT	Flag
 23, 49, 75, 101	Heating / cooling change-over	Output 1-4	1-bit	1,100	C, W, -, (R) ₁

Description 1-bit object for switching over between heating and cooling operation during automatic heating/cooling. The polarity can be configured. This object is generally linked with room temperature controllers (object "heating/cooling switchover").

Function: Position feedback

Object	Function	Name	Type	DPT	Flag
 24, 50, 76, 102	Position feedback ²	Output 1-4	1 byte	5,001	C, -, T, R ^{1,3}

Description 1-byte object for position feedback of the Venetian blind or roller shutter height or louver position (0...255).

Function: Position feedback

Object	Function	Name	Type	DPT	Flag
 25, 51, 77, 103	Slat position feedback	Output 1-4	1 byte	5,001	C, -, T, R ^{1,3}

Description 1-byte object for position feedback of the slat position (0...255) if one shutter is controlled.

Function: Position feedback

Object	Function	Name	Type	DPT	Flag
 26, 52, 78, 104	Invalid position feedback	Output 1-4	1-bit	1,002	C, -, T, R ^{1,3}

Description 1-bit object for reporting back an invalid position of the Venetian blind or roller shutter height or louver position ("0" = position valid / "1" = position invalid).

1: Each communication object can be read out. For reading, the R-flag must be set.

2: The object designation varies with the type of blind (Venetian blind, roller shutter / awning, venting louver).

3: Depending on the configuration, feedback objects are either actively transmitting (T flag set) or passively readable (R flag set).

Function: Drive movement feedback

Object	Function	Name	Type	DPT	Flag
 27, 53, 79, 105	Drive movement feedback	Output 1-4	1-bit	1,002	C, -, T, R ^{1,2}

Description 1-bit object for feedback of an active drive movement (output energised - up or down). ("0" = no drive movement / "1" = drive movement).

Function: Presetting the position

Object	Function	Name	Type	DPT	Flag
 28, 54, 80, 106	Position ³	Output 1-4	1 byte	5,001	C, W, -, (R) 1

Description 1-byte object for presetting a position value (0...255) for the height of the Venetian blind or roller shutter or the venting louver position in direct operation.

Function: Presetting the position

Object	Function	Name	Type	DPT	Flag
 29, 55, 81, 107	Slat position	Output 1-4	1 byte	5,001	C, W, -, (R) 1

Description 1-byte object for presetting a slat position value (0...255) in direct operation.

1: Each communication object can be read out. For reading, the R-flag must be set.

2: Depending on the configuration, feedback objects are either actively transmitting (T flag set) or passively readable (R flag set).

3: The object designation varies with the type of blind (Venetian blind, roller shutter / awning, venting louver).

4.2.4 Functional description

4.2.4.1 Description of channel-independent functions

Delay after bus voltage return

To reduce telegram traffic on the bus line after bus voltage activation (bus reset), after connection of the device to the bus line or after programming with the ETS, it is possible to delay all actively transmitted feedback telegrams of the actuator. For this purpose, a channel-independent delay can be specified (parameter "Delay after bus voltage return" on parameter page "General"). Only after the configured time elapses are feedback telegrams for initialisation transmitted to the bus.

Which of the feedback telegrams is actually delayed and which is not can be specified for each output channel and for each feedback function separately.

- i** The delay has no effect on the behaviour of the outputs. Only the feedback telegrams are delayed. The outputs can also be activated during the delay after bus voltage return.
- i** A setting of "0" for the delay after bus voltage return deactivates the delaying function altogether. In this case, all feedback telegrams, if actively transmitted, will be transmitted to the bus without any delay.

Central function

The actuator offers the possibility of linking selected individual or all output channels with a 1-bit central communication object. The behaviour in case of activating an output via the central function is comparable to a central group address linked with all "Long time operation" objects. The outputs assigned to the central function are activated in accordance with the central object value received. If necessary, the polarity of the central telegram can be configured as inverted. The behaviour of the channels is identical with the 'normal' activation via the "Long-time operation" objects. In this case the central telegram has got the same priority so the command last received (long-time or central) will be executed .

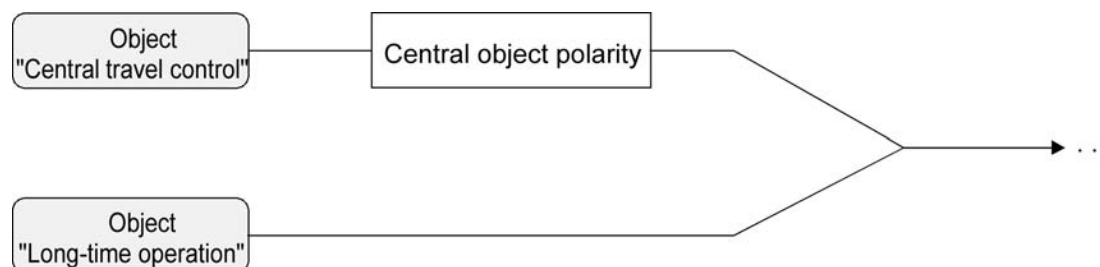

Figure 6: Function diagram "Central movement"

Enabling the central function

- Enable the central function on parameter page "General" by setting the "Central function ?" parameter to "Yes".
The "Central movement" communication object is visible.

Assigning outputs to the central function

Each output can be assigned independently to the central function.

The central function must have been enabled on parameter page "General". The assignment has otherwise no effect on the Venetian blind output.

- Set the "Assignment to central function" parameter on parameter page "Ax-Enabled functions" (x = number of output) to "Yes".

The appropriate output is assigned to the central function. It can be moved centrally.

- i** The blind, venting louvre or slat position newly set by the central function is tracked at the end of a travel movement in the feedback objects and also transmitted to the bus, if these are actively transmitting. It should be noted that the Venetian blind actuator can compute positions after application of the supply voltage only if a reference movement into the upper limit positions has been performed beforehand.

- i** The central function belongs to the set of 'direct operations' of an output. For this reason, the central function has the same priority compared with operation using the short time or long time objects, used to control the positioning objects or to recall scenes.
- i** After a bus voltage return or after programming with the ETS, the central function is always inactive (object value "0").

Manual operation

All outputs of the shutter actuator can also be operated manually. The button field with 4 function keys and 3 status LEDs on the front panel of the device can be used for setting the following modes of operation...

- Bus control: operation from touch sensors or other bus devices
- Temporary manual control: manual control locally with keypad, automatic return to bus control,
- Permanent manual control: local manual control with keypad.

The operation of the function keys, the control of the outputs and the status display are described in detail in chapter "Operation".

The parameterisation, status feedback, disabling via a bus telegram, and interaction with other functions of the shutter actuator when manual control is activated and deactivated are described in greater detail below.

Manual control is possible only while the actuator is supplied with power from the external supply voltage. The actuator is delivered with the manual control mode fully enabled. In this unprogrammed state, the individual outputs can be switched on and off also without bus voltage so that fast function checking of the connected drives (e.g. on the construction site) is possible.

After initial commissioning of the actuator via the ETS, manual control can be enabled or disabled separately for various states of operation. Manual control can, for instance, be disabled during bus operation (bus voltage applied). Another option consists in the complete disabling of the manual control only in case of bus voltage failure. Therefore manual control can be disabled completely, if the bus disable and bus failure disable are active.

Enabling the manual control mode

Manual control for the different states of operation is enabled or disabled by means of the parameters "Manual control in case of bus voltage failure" and "Manual control during bus operation" on the "Manual control" parameter page.

- Set the parameter "Manual control in case of bus voltage failure" to "enabled".

Manual control is then basically enabled when the bus voltage is off. This setting corresponds to the setting of the actuator as delivered.

- Set the parameter "Manual control in case of bus voltage failure" to "disabled".

Manual control is completely disabled when the bus voltage is off. In this case, bus operation is not possible either so that the outputs of the actuator can no longer be actuated.

- i** In the configuration "Manual control in case of bus voltage failure = disabled", bus voltage failure will not terminate manual control if previously activated. The parameter configuration only has an effect if manual control is terminated first by key operation on the device. Manual control can then not be activated while the bus voltage is switched off.

- Set the parameter "Manual control during bus operation" to "enabled".

Manual control is then basically enabled when the bus voltage is on. The outputs of the actuator can be operated via the bus or manually. This setting corresponds to the setting of the actuator as delivered.

- Set the parameter "Manual control during bus operation" to "disabled".

Manual control is completely disabled when the bus voltage is on. In this configuration, the actuator outputs can only be operated via the bus.

- i** Further parameters and communication objects of the manual control are visible only in the configuration "Manual control during bus operation = enabled". For this reason, the disabling function, the status message and bus control disabling can only be configured in the above parameter setting.

Presetting the behaviour at the beginning and at the end of manual control.

Manual control is divided into temporary and permanent manual control. Depending on these modes, the actuator behaves differently, especially at the end of the control mode. It should be noted that the operation via the bus, i.e. control of the outputs by direct operation (move / step / position / scene / central) or by the sun protection and safety functions is always disabled when the manual control is active. This means that the manual control mode has the highest priority.

Behaviour at the beginning of manual control:

The behaviour at the beginning of manual control is the same for both temporary and permanent manual control. When manual control is activated, all travel movements that were started beforehand by bus control will still be completed unless the travel movement in question is stopped by hand.

An active forced-position, safety and sun protection function can be overridden by manual control. These functions are reactivated after deactivation of the manual mode unless they have been cancelled in the meantime.

Behaviour at the end of manual control:

The behaviour at the end of manual control is different depending on whether it is temporary manual control or permanent manual control.

The temporary manual mode is shut off automatically when the last output has been addressed and when the select key is pressed once more. During a shutoff of the temporary manual control mode, the actuator goes back to 'normal' bus operation and does not change the state selected by manual control. If, however, a forced position, safety or sun protection function (independent of priority) has been activated via the bus before or during manual control, the actuator executes these functions of a higher priority again for the outputs concerned.

The permanent manual control mode is shut off, when the select key is pressed for more than 5 s. Depending on the parameterization of the actuator in the ETS, the outputs will be set to the state last adjusted in the manual mode or to the state internally tracked (direct operation, forced position, safety or sun protection position) when the permanent manual mode is shut off. The parameter "Behaviour at the end of permanent manual control during bus operation" defines the corresponding reaction.

- Set the parameter "Behaviour at the end of permanent manual control during bus operation" to "no change".

All telegrams received during an active permanent manual control mode for direct operation (long-time/short-time, positioning, central, scenes) will be rejected. After the end of the permanent manual control mode, the current state of all outputs remains unchanged. If, however, a forced position, safety or sun protection function (independent of priority) has been activated via the bus before or during manual control, the actuator executes these functions of a higher priority again for the outputs concerned.

- Set the parameter "Behaviour at the end of permanent manual control during bus operation" to "track outputs".

During an active permanent manual control all incoming telegrams (short-time telegrams – step/stop excepted) are internally tracked. At the end of the manual control mode, the outputs will be set to the tracked states or to the absolute positions last set before the permanent manual control mode. A long-time operation is not tracked, if the output is already in the corresponding end position.

- i** The behaviour at the end of the permanent manual control when the bus voltage is off (only manual control) is permanently set to "no change".
- i** The control operations triggered in the manual control mode will be transmitted via feedback objects to the bus, if enabled and actively transmitting.
- i** On return of bus voltage or after programming with the ETS an activated manual control mode will always be terminated. In this case, the parameterized or predefined behaviour at the end of manual control will not be executed. The actuator executes the parameterized behaviour on bus voltage return or after ETS programming instead.

Presetting a manual control disable

The manual control mode can be separately disabled via the bus, even if it is already active. If the disabling function is enabled, then as soon as a disabling telegram is received via the disabling object of the manual control, the actuator immediately terminates an activated manual control and locks the function keys on the front panel of the device. The telegram polarity of the disabling object is parameterisable.

The manual control mode during bus operation must be enabled.

- Set the parameter "Disabling function ?" on parameter page "Manual control" to "yes".
The disabling function of the manual control mode is enabled and the disabling object is visible.
- Select the desired telegram polarity in the "Disabling object polarity" parameter.
- i** If the polarity is "0 = disabled; 1 = enabled", the disabling function is immediately active on return of bus voltage or after an ETS programming operation (object value "0"). To activate the manual control in this case, an enable telegram "1" must first be sent to the disabling object.
- i** In case of bus voltage failure, disabling via the disabling object is always inactive (depending on parameterization, the manual control is then either enabled or completely disabled). After return of bus voltage a disabled state that was active before will be reactivated. The disabled state will be deactivated only after an enabling telegram has been received. In the event of failure of the bus and supply voltage the disable is deactivated via the disabling object. An interruption of the supply voltage alone has no effect on the disabled state of the manual control.
- i** When an active manual control is terminated by a disable, the actuator will also transmit a "Manual control inactive" status telegram to the bus, if the status messaging function is enabled.

Presetting the status message function for the manual control mode

The actuator can transmit a status message to the bus via a separate object, when the manual control mode is activated or deactivated. The status telegram can only be transmitted when the bus voltage is present. The polarity of the status telegram can be parameterized.

The manual control mode during bus operation must be enabled.

- Set the parameter "Transmit status ?" on the "Manual control" parameter page to "yes".
The status messaging function of the manual mode is enabled and the status object is visible.
- Specify in the parameter "Status object function and polarity" whether the status telegram is generally a "1" telegram whenever the manual control mode is activated or only in those cases where the permanent manual mode is activated.
- i** The status object is always "0", when the manual control mode is deactivated.
- i** The status will be actively transmitted to the bus ("0") only if a manual control that was activated during bus voltage failure is terminated by the return of the bus voltage. The status telegram is in this case transmitted without delay. After bus voltage return or after programming with the ETS, the value of the status object is " 0 " and can also be read out.
- i** When an active manual control is terminated by a disable, the actuator will also transmit a "Manual control inactive" status telegram to the bus.

Setting disabling of the bus control

Individual outputs can be disabled locally, so that the disabled outputs can no longer be controlled via the bus. Such disabling of the bus operation is initiated by operation in permanent manual control and is indicated by rapid flashing of the status LEDs of the outputs concerned. The disabled outputs can then only be activated in permanent manual control.

The manual control mode during bus operation must be enabled.

- Set the parameter "Disable bus control of individual outputs during bus operation" on parameter page "Manual control" to "yes".
The function for disabling the bus control is enabled and can be activated locally. As an alternative, this parameter can be set to "no" to prevent activation of disabling of the bus control in permanent manual control.

- i** The disabling initiated locally has the highest priority. Thus all other functions of the actuator that can be activated via the bus (e.g. forced position or safety function) are overridden. Depending on the parameterization of the actuator in the ETS, the outputs will be set to the state last adjusted in the manual mode or to the state internally tracked (direct operation, forced position, safety or sun protection position) when the permanent manual mode is reactivated and subsequently shut off.
- i** Any disabling of the bus control activated locally is not reset in case of bus voltage failure or return. Even a supply voltage failure does not by itself reset the disabling. A failure of the bus and supply voltage does, however, deactivate the disabling of the bus control.

Safety functions:

The shutter actuator can handle up to five different safety functions. Each safety function has a communication object of its own so that the functions can be activated or deactivated independently of one another.

There are three different wind alarms available. These alarms can be used, for instance, to protect Venetian blinds or awnings on several building facades from wind and gusts. In addition or as an alternative, a rain alarm, for instance, as a protection for awnings, and a frost alarm as a protection against mechanical damage to lowered Venetian blinds in low temperatures can be activated and used. The telegram polarity of the safety objects is fixed:

"0" = No alarm / "1" = Alarm.

Usually, weather stations, which record temperature, wind speed and rain via the sensors, control the communication objects of the safety function.

The safety functions are programmed and configured in common for all shutter/blind outputs.

The different outputs of the actuator can be separately assigned to all or to individual safety functions. Only assigned outputs respond to a change in the state of the safety objects. The reactions at the beginning of an alarm message ("1" telegram) or at the end of an alarm message ("0" telegram) can be parameterized for each channel.

Because outputs are also assigned to multiple safety alarms, the priority of incoming alarm messages can be preset for several channels. Thus, the three wind alarms have the same priority with respect to one another (logic OR). The order of priority of the wind alarms with respect to the frost alarm or to the rain alarm can be parameterized.

The communication objects for the safety alarms can be monitored for the arrival of cyclical telegrams. If there are no telegrams within a settable monitoring time, the device activates the safety movement for the output. The safety function is terminated as soon as a new "0" telegram is received.

For the wind alarms, the rain alarm and the frost alarm, different monitoring times between '1 minute' and '23 hours 59 minutes' can be separately selected in the ETS. A shared time is configured for the wind alarms. Each wind alarm has its own timer so that the wind objects are separately checked for telegram updates.

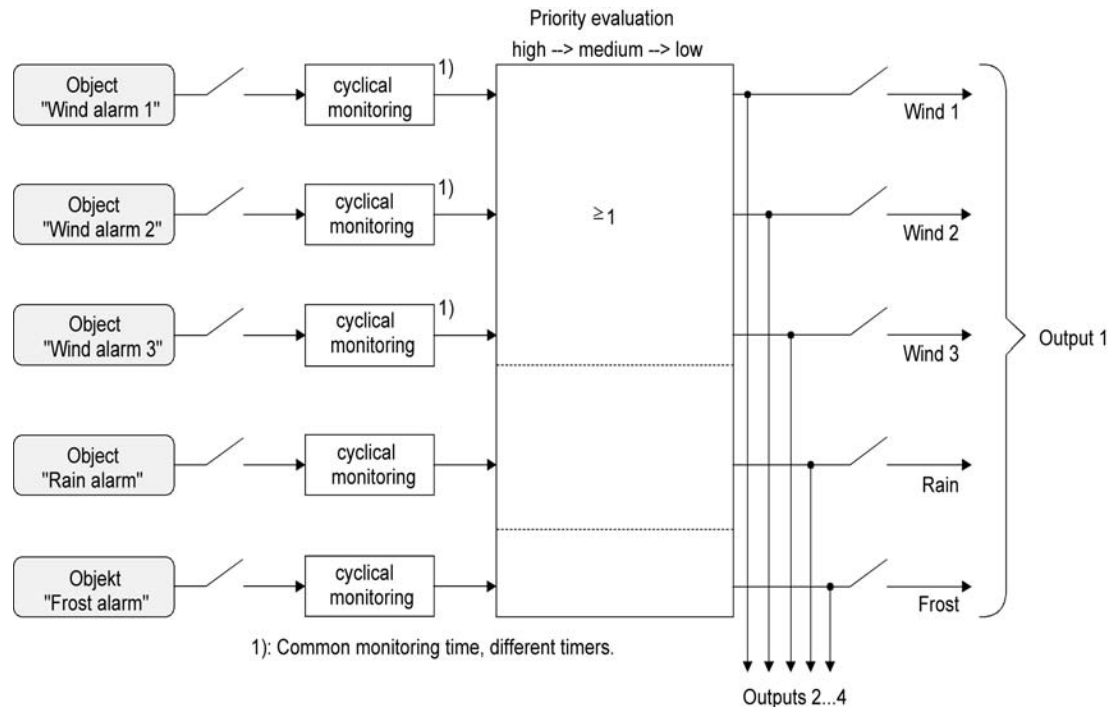

Figure 7: Function diagram of safety functions

Enabling the safety functions

The safety functions must first be globally enabled before they can be parameterized and used. After global enabling, the individual safety alarms can be enabled or disabled independently of one another.

- Set the parameter "Safety functions" on the "Safety" parameter page to "enabled".
The safety functions are globally enabled and the other parameters and the parameter page "Safety times" become visible.
- Set the parameters "Wind alarm 1", "Wind alarm 2", "Wind alarm 3", "Rain alarm" and "Frost alarm" depending on functional requirements to "enabled". The "disabled" option deactivates the corresponding alarm.

The necessary safety alarms are now enabled. The safety objects are visible and can be linked with group addresses.

- i** It should be noted that the channel-oriented assignment of shutter outputs to the safety alarms (on parameter pages "Ax – Safety"; x = number of output) is operational only after the corresponding alarm has been enabled. Otherwise, an assignment is without function.
- i** An update of the safety objects ("ON" to "ON" or "OFF" to "OFF") shows no reaction.
- i** After failure of the bus and supply voltage or after programming with the ETS, the safety functions are always deactivated. If only the external supply voltage or only the bus voltage fails, the object states of the safety functions are not lost and the functions remain activated, if they were activated before. In this case it should be noted, however, that the configured behaviour will be executed when the bus or supply voltage returns (parameter "Behaviour after bus or supply voltage return"). After such action, the outputs are, however, safety-locked and cannot be operated via the bus anymore unless the safety functions assigned are terminated.

Presetting the safety priorities

If several safety alarms are assigned to an output, it is important to preset the priority of the incoming safety telegrams. An alarm with a higher priority overrides the alarms with the lower priorities. When a safety alarm with the higher priority has ended, the safety alarm with the lower priority is executed on condition that it is active.

The safety functions must have been globally enabled.

- Arrange the "Priority of safety alarms" parameters on the "Safety" parameter page in the required order of priority.
- ⓘ The three wind alarms have the same priority with respect to one another (logic OR). The last telegram update to the wind alarm objects decides which of the wind alarms will be executed. The wind alarm is completely deactivated for an assigned output only after all three objects are inactive ("0").

Presetting cyclical monitoring

If cyclical telegram monitoring of the safety objects is necessary, the individual monitoring functions must be activated separately. The monitoring functions must be enabled and the monitoring times preset on the "Safety times" parameter page.

The safety functions must have been globally enabled.

- If monitoring of the wind alarms is to be activated, the parameter "Use wind alarm monitoring function ?" must be set to "yes".
The monitoring function for the wind alarm objects is now activated. As soon as the monitoring function is activated, telegrams must be transmitted cyclically to all enabled wind alarm objects. If only one of the wind alarm telegrams is missing within the monitoring period, the wind alarm reaction will be executed for the output concerned.
- Specify the required monitoring time for the wind alarm objects in the "Wind alarm monitoring times" parameters.
- If the monitoring function is to be activated for a rain alarm, the parameter "Use rain alarm monitoring function ?" must be set to "yes".
The monitoring function for the rain alarm object is now activated. As soon as the monitoring function is activated, telegrams must be transmitted cyclically to the rain alarm object.
- Specify the required monitoring time for the rain alarm object in the "Rain alarm monitoring times" parameters.
- If the monitoring function is to be activated for a frost alarm, the parameter "Use frost alarm monitoring function ?" must be set to "yes".
The monitoring function for the frost alarm object is now activated. As soon as the monitoring function is activated, telegrams must be transmitted cyclically to the frost alarm object.
- Specify the required monitoring time for the frost alarm object in the "Frost alarm monitoring times" parameters.
- ⓘ The monitoring function for the wind alarms may only be activated, if at least one wind alarm has been activated on the "Safety" page.
- ⓘ The cycle time of the transmitters should be shorter than the monitoring time parameterized in the blind actuator in order to ensure that at least one telegram can be received during the monitoring time.

4.2.4.2 Channel-oriented functional description

Operating mode

Each output of the Venetian blind actuator can be independently configured for the drive type connected by defining the mode of operation. The device permits controlling slatted Venetian blinds, roller shutters, awnings and also venting louvres. Depending on the preset operating mode, the ETS adapts the parameters and communication objects for all functions of an output. For example, in the "Venetian blind" operation mode, there are also parameters and objects for slat control. There is no slat control in the "Roller shutter / awning" operating mode, but a fabric stretching function can be configured for awning use. In the "Venting louvre" operation mode, a distinction is made between the "Closing" and "Opening" drive movements, instead of an up or down movement for Venetian blinds or roller shutters.

In this documentation, Venetian blinds, roller shutters or awnings are also designated with the term "blind", if the text does not explicitly refer to a particular function (e.g. slat control). In all modes it is possible to specify positions.

Presetting the operating mode

The parameter "Mode of operation" exists separately for each shutter output on the parameter page "Ax General" (x = number of output).

- Select the required operating mode in the "Operating mode" parameter.
- i** The "Operating mode" parameter has an influence on many channel-oriented parameters and communication objects. When the operating mode is changed in the ETS, the parameters are adapted dynamically so that settings already made or links between group addresses can be reset. For this reason, the required operating mode should be configured at the beginning of the channel-oriented device configuration.
- i** Venting louvres must be connected to the outputs in such a way that they are opened in the movement direction "up - ▲" and closed in the movement direction "down - ▼".
- i** An awning travels upwards when it is rolled up.

Behaviour in case of bus voltage failure, after bus or supply voltage return or after programming with the ETS

The preferred states of the relay contacts in case of bus voltage failure or bus or supply voltage return and after ETS programming can be preset separately for each output. Since the actuator is equipped with externally-supplied monostable relays, the relay switching state at bus voltage failure can be defined as well.

Presetting the behaviour after ETS programming

The parameter "Behaviour after ETS programming" can be preset separately for each output channel on the parameter page "Ax - General" (x = number of output). This parameter can be used to configure the relay behaviour of the output irrespective of the behaviour after a bus or supply voltage return.

Depending on the selected operating mode, the ETS adapts the designations of the parameter settings ("raising" ↔ "opening the louver" / "lowering" ↔ "closing the louver").

- Set the parameter to "stop".
After programming with the ETS, the actuator switches the relays of the output to the "stop" position. A drive movement, if any, will be interrupted.
- Set the parameter to "raising" or "opening the louver".
After programming with the ETS, the actuator raises the blind or opens the venting louvre.
- Set the parameter to "lowering" or "closing the louver".
After programming with the ETS, the actuator lowers the blind or closes the venting louvre.
- i** At the beginning of each ETS programming cycle, the shutter actuator always executes a "stop" command for all outputs. The manual mode, if active, will be terminated.
- i** The "Behaviour after ETS programming" as parameterized will be executed after every ETS application or parameter download. A simple download of the physical address alone or partial programming of only the group addresses has the effect that this parameter is disregarded and that the parameterized "Behaviour after bus or supply voltage return" will be executed instead.

- i** Programming with the ETS is possible when the bus voltage line is connected to the shutter actuator and the bus voltage supply is on. The external voltage supply is not required for an ETS download. If programming with the ETS was performed with bus voltage only, the parameterized "Behaviour after ETS programming" will only be executed when also the voltage supply of the actuator has been switched on. This does not activate the "behaviour after a bus or supply voltage return"! This response should be noted especially for actuators that are installed in an electrical installation in a preprogrammed state.
- i** After programming with the ETS, the safety functions, the forced positions and the sun protection function are always deactivated.

Presetting the behaviour in case of bus voltage failure

The parameter "Behaviour in case of bus voltage failure" can be preset separately for each output channel under "Ax - General" (x = number of output). The parameter defines the behaviour of a shutter output if only the bus voltage fails. The parameterized behaviour will not be adopted, if a manual control mode is active at the time of bus failure (state LEDs blinking in case of temporary or permanent manual control).

Depending on the selected operating mode, the ETS adapts the designations of the parameter settings ("raising" ↔ "opening the louver" / "lowering" ↔ "closing the louver").

- Set the parameter to "stop".
In case of bus voltage failure, the actuator switches the relays of the output to the "stop" position. A drive movement, if any, will be interrupted.
- Set the parameter to "raising" or "opening the louver".
After bus voltage failure, the actuator raises the blind or opens the venting louver.
- Set the parameter to "lowering" or "closing the louver".
After bus voltage failure, the actuator lowers the blind or closes the venting louver.
- Set the parameter to "position approach".
In case of bus voltage failure, the connected drive can approach a position specified by further parameters (0...100 %). If Venetian blinds are controlled with the device, the slats can be positioned independently. The shutter actuator performs a reference travel before the position approach, if the current position at the time of bus failure is unknown (e.g. due to power supply failure or to previous ETS programming).
- Set the parameter to "no reaction".
In the event of bus voltage failure, the relay of the output shows no reaction. Motions still in progress at the time of failure will still be completed as long as the mains voltage supply is still on.
- i** Safety, forced position or sun protection functions (independent of the selected priority) remain active even after a bus voltage failure as long as the external voltage supply is still on. These functions will therefore be executed again at the end of a temporary or permanent manual control (if enabled in case of bus failure) even if there is no bus voltage.
- i** When the still ongoing motion or the motion parameterized in case of bus voltage failure has come to an end, the outputs can no longer be activated except by manual control (if the supply voltage is on and if manual control is enabled) or by bus/supply voltage return.
- i** A bus voltage failure will in any case result in a stop of all time functions. Thus, all scene recalls in the delay phase will be aborted and all delay times for sun protection and presence will be ended by ignoring the object value last received and still in the delay phase. A telegram update received shortly before bus voltage failure is then lost, if the corresponding delay has not yet elapsed.
- i** In the event of a supply voltage failure, all relays of the actuator will always drop out ("stop") independent of the bus voltage condition. In this state the outputs can no longer be activated. Time functions (scene, sun protection and presence delays) are not interrupted, if only the supply voltage fails.

- i** When there is a bus or supply voltage failure, the current position data is permanently saved internally, so that these position values can be accurately repositioned after bus or supply voltage return, should this be configured. The data are stored before the reaction parameterized for the case of bus voltage failure takes place and only if one part of the bus or supply voltage is still present, or if the bus or supply voltage fails completely after the external voltage has been available before without interruption for at least 20 seconds after the last reset (storage capacitors sufficiently charged for storage purposes). The data will not be stored, if the position data is unknown. The saving process is performed only once after the failure of bus or supply voltage...

Example 1:

Bus voltage failure -> Data storage -> Then supply voltage failure -> No further data storage,

Example 2:

Bus voltage failure -> Data storage -> Then bus voltage failure -> No further data storage,

The following rules apply for the position data to be stored:

The current blind, slat and louver positions are stored. With Venetian blinds, the height to be stored is always referred to a slat position of 100 % (cf. "Calculating the slat position"). Positions temporarily approached will be stored also for those outputs that are involved in a travel movement at the time of data storage. On account of the fact that position data is stored as integer percentage values (0..100), a minor deviation from the positions reported back later upon bus or supply voltage return (number range 0..255) cannot be avoided.

Because the position data are saved only once in the event of bus voltage failure, positions that are changed after a bus voltage failure, for example via manual control, are not tracked! Similarly, forced position telegrams received via the bus after a supply voltage failure or slat offset positions for the sun protection function cannot be stored and tracked either. Stored position data are not lost during programming with the ETS.

In case of ETS programming, the saved position data is not lost.

- i** In case of bus or supply voltage failure, the current states of the forced position control or – if parameterized – also the slat offsets of the sun protection positions are stored as well.

Behaviour in case after bus or supply voltage return

The parameter "behaviour after a bus or supply voltage return" can be preset separately for each output channel on the parameter page "Ax – General" (x = number of output). Depending on the selected operating mode, the ETS adapts the designations of the parameter settings ("raising" ↔ "opening the louver" / "lowering" ↔ "closing the louver").

- Set the parameter to "stop".
In case of bus or supply voltage return, the actuator switches the relays of the output to the "stop" position. A drive movement, if any, will be interrupted.
- Set the parameter to "raising" or "opening the louver".
After bus or supply voltage return, the actuator raises the curtain or opens the venting louver.
- Set the parameter to "lowering" or "closing the louver".
After bus or supply voltage return, the actuator lowers the curtain or closes the venting louver.
- Set the parameter to "position during bus / supply failure".
After bus or supply voltage return, the forced position value (including slat position for Venetian blinds) last selected and internally stored before bus or supply voltage failure will be tracked. The shutter actuator performs a reference travel before the position approach, if the current position at the time of bus or supply voltage failure is unknown.
- Set the parameter to "position approach".
In case of bus or supply voltage return, the connected drive can approach a position (0...100 %) specified by further parameters. If Venetian blinds are controlled with the device, the slats can be positioned independently. The shutter actuator performs a reference travel before the position approach, if the current position at the time of bus or supply voltage failure is unknown.

- Set the parameter to "no reaction".
In the event of bus or supply voltage return, the relay of the output shows no reaction. Any movements still in progress at the instant when voltage returns will still be completely finished.
- ❗ "Position during bus / supply failure" setting: If no position values could be stored in case of bus or supply voltage failure because the position data were unknown (no reference travel executed), the actuator shows no reaction with this parameterization either.
- ❗ "No reaction" setting: The commands received via the bus during a supply voltage failure (bus voltage present) are tracked when the supply voltage returns. Interrupted short- or long-time travel movements – if not completed – are restarted at full length and position approaches are continued from the break point.
- ❗ All time functions (scene, sun and presence delay) are only stopped in case of bus voltage failure so that a supply voltage failure does not result in a loss of states or time functions as long as the bus voltage is present.
- ❗ The parameterized behaviour is always executed independent of the current states of the safety or sun protection function. Safety and sun protection function can nonetheless be active even after bus or supply voltage return, if these functions have been activated before a bus voltage failure or before or during a supply voltage failure. Any direct operation can thus be overridden.
Only in case of failure of bus voltage and supply voltage are the sun protection or the safety functions deactivated.
- ❗ The forced position communication object can be initialised separately after bus voltage return. This has an effect on the reaction of the output when the forced position is activated. A supply voltage failure alone has no effect on the forced position. If only the supply voltage returns, a previously activated forced position remains active.
The configured "behaviour upon bus or supply voltage return" will only be executed if no forced position on bus voltage return is activated.
- ❗ After return of bus voltage a manual control will be interrupted.. In case of supply voltage failure, no manual control is possible.
- ❗ The device only executed the configured "behaviour upon bus or supply voltage return" if the last ETS programming of the application of the parameters ended at least approx. 20 s prior to switching on bus and supply voltage. Otherwise ($T_{ETS} < 20$ s), the "Behaviour after ETS programming" will be adopted also in case of bus / supply voltage return.
If only the bus- or the supply voltage fails after an ETS download and is then restored, the actuator executes the "behaviour upon bus or supply voltage return".

Determining and configuring short-time and long-time operation

The short-time operation (Step) permits adjusting the slat tilting angle of a blind or the 'slit opening width' of a shutter. In most cases, short-time operation is activated by pressing a Venetian blind pushbutton sensor permitting manual intervention in the blind controller. When the actuator receives a short-time command while the blind, shutter, awning or louver is in motion, the travel movement is stopped immediately by the shutter actuator.

Long-time operation(Move) is determined by the travelling time of the connected blind, shutter, awning or louver and must therefore not be preset separately. The movement time must be measured 'manually' and entered into the ETS parameters. The control of an output by means of a long-time or a short-time telegram is also designated as 'direct operation'.

To ensure that the curtain or the venting louver has definitely reached its end position at the end of long-time operation, the shutter actuator always prolongs the long-time movement by 20% of the parameterized or learnt travelling time.

The parameterized travelling time extension will moreover be taken into account by the actuator for all upward travels or all travel movements into the open position as the drive motors are then generally no so fast due to the weight of the curtains or to external physical influences (e.g. temperature, wind, etc.). Thus, it is ensured that the upper end position is always reached even in case of uninterrupted long time travel movements.

- ❗ A long time or a short time operation can be retriggered by a new incoming long time or short time telegram.
- ❗ A travel movement activated in the manual control mode or by a safety function is always a long-time operation. The "raising" or "lowering" commands configured in the ETS will equally activate the long time operation.

Presetting the short time operation

Short-time operation is configured separately for each output and independent of the travelling time of the curtain or of the louvre. It is possible to specify in the ETS whether the output executes only a "stop" for a travel movement on reception of a short time telegram or whether the output is activated for a specific duration.

- Set the parameter "Short time operation" on parameter page "Ax - Time settings" (x = number of output) to "yes".

The Venetian blind actuator activates the output concerned for the time specified under "Duration of short time operation" when a short time telegram is received and when the output is not in the process of executing a travel movement. If the output is executing a travel movement at the time of telegram reception, the output will only just stop.

- Set the parameter "Short time operation" on parameter page "Ax - Time settings" (x = number of output) to "no (only stop)".

The Venetian blind actuator will only stop the output on reception of a short time telegram, if the output is in the process of executing a travel movement. There will be no reaction, if the output is not executing a movement at the time of telegram reception.

- i** The configured "Duration of short time operation" should correspond, for a Venetian blind, to approx. $\frac{1}{4}$ of the complete slat moving time and for a roller shutter to the full time needed for opening the roller shutter segments.
- i** The short time operation is always executed without a movement time extension.

Determining and configuring travelling times

For computing positions and also for executing long-time operation, the shutter actuator needs the exact travelling time of the connected blind, shutter, awning or venting louver. For a blind output the movement time must be measured 'manually' and entered into the ETS configuration. It is important to determine the movement time accurately to permit positions to be approached with good precision. Therefore, it is recommended to make several time measurements and to take the average of these values before entering them into the corresponding parameter. The movement time corresponds to the duration of a drive movement from the completely open position (upper end position / awning rolled up) to the completely closed position (lower end position / awning completely unrolled). Not vice-versa! The movement times are to be determined as a function of the different types of drives.

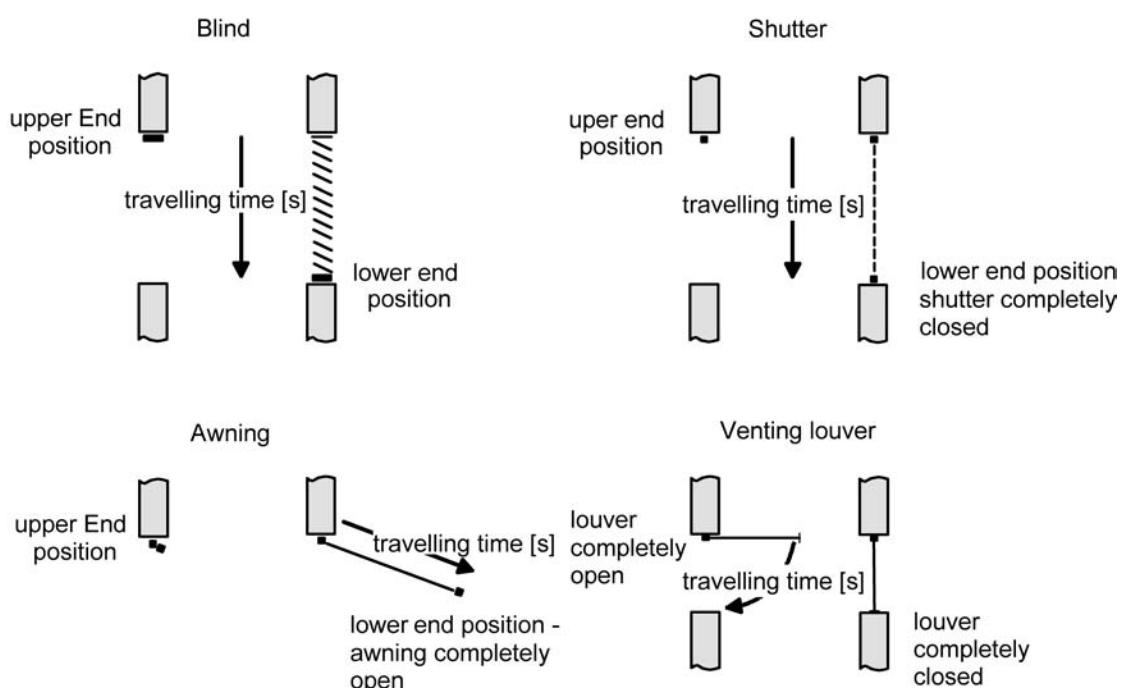

Figure 8: Determining the movement time according to the drive type

Setting the movement time of Venetian blinds, roller shutters/awnings and louvers

The measurement of the movement time is described in detail in chapter "Commissioning".

- Enter the exact travelling times determined in the course of the commissioning procedure into the parameters "Blind travelling time" or "Shutter/awning travelling time" or "Venting louver travelling time" on parameter page "Ax – Time settings" (x = number of output). The maximum travelling time is '19 minutes 59 seconds. The working principle does not allow longer movement times.
- ❗ The parameterized travelling time extension will moreover be taken into account by the actuator for all upward travels or all travel movements into the open position as the drive motors are then generally no so fast due to the weight of the curtains or to external physical influences (e.g. temperature, wind, etc.).

Determining and configuring the slat moving time (only with slatted Venetian blinds)

If Venetian blinds are controlled, the slats can be positioned independently. To enable the blinds actuator to compute slat positions and to report them back to the bus, it is necessary that the actuator gets precise information about the time required for a slat rotation. The slat moving time must in each case be determined and configured 'manually'.

The blinds actuator is designed in such a way that it can control single-motor Venetian blind drives without a working position. In this drive mode, the slats are directly adjusted by way of mechanical linkage when the height of the Venetian blind is changed. The actuator assumes that the slats are completely closed when the blind moves downwards. The actuator assumes that the slats are completely closed when the Venetian blind moves downwards (Figure 9). These Venetian blinds are the most common type on the market.

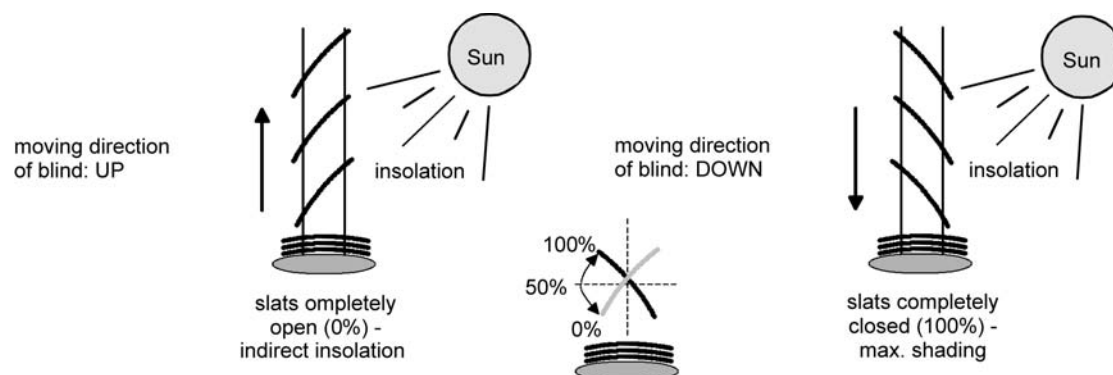

Figure 9: Type 1 - Slatted Venetian blinds with oblique slat position in both travel directions

There are also single-motor Venetian blind systems without a working position the slats of which are horizontal during an upward travel and oblique during a downward travel. Such blind types can also be connected to the actuator in which case a completely open slat position corresponds to the slats in horizontal position .

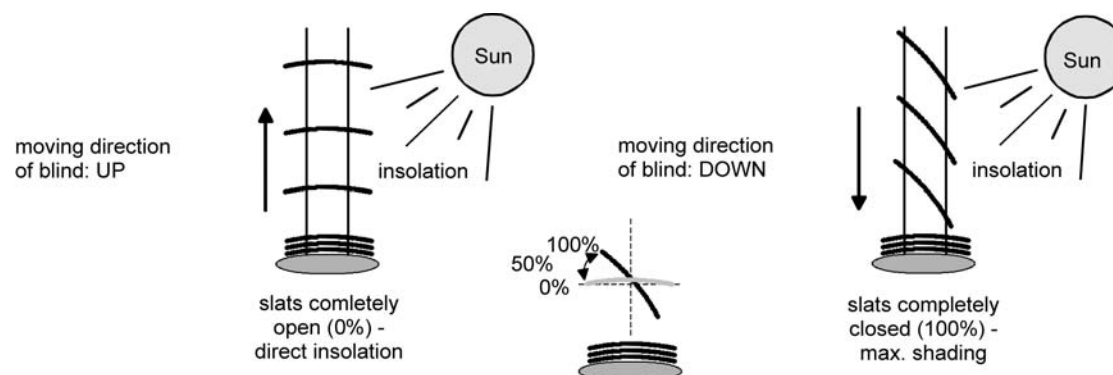

Figure 10: Type 2 - Slatted Venetian blinds with oblique and horizontal slat position

Presetting the slat moving time

The measurement of the slat moving time is described in detail in chapter "Commissioning".

- Set the parameter "Slat moving time" on parameter page "Ax – Times" (x = number of output) exactly to the value determined in the course of the commissioning procedure.
- i** The slat moving time must be shorter than the preset or learnt blind travelling time.
- i** The configured movement time extension will also be taken into account when slats are moved into the completely open position (upward movement).

Determining and configuring the movement time extension and the switchover time

When travelling upwards, blinds, shutters or awnings have a tendency of moving more slowly due to their own weight or to external physical influences (e.g. temperature, wind, etc.). The same applies to venting louvers where opening may take longer than closing.

For this reason, the blinds actuator takes the parameterized travelling time extension into account when moving upwards or when opening louvers. The extension is computed as a percentage of the difference of the movement times in both directions.

The movement time extension should be determined separately for each output during commissioning and entered into the ETS configuration. The measurement of the movement time extension is described in detail in chapter "Commissioning".

Example for determining the movement time extension:

- "Movement time" previously determined and configured: $T_{OU} = 20$ seconds,"
- Time determined for movement from lower to upper end position: $T_{UO} = 22$ seconds,
- Calculated supplementary travelling time: $T_{UO} - T_{OU} = 2$ seconds -> 2 seconds out of 20 seconds are 10 %,
- Movement time extension to be configured: 10 %.

To protect the drive motors from irreparable damage, a fixed pause during movement direction switch-over can be configured for each output. During the pause, no movement direction is active ("stop"). The necessary parameter value can normally be found in the technical documents of the drive motor used. The change-over time is accounted for in every state of operation of the actuator.

Presetting the movement time extension

- Enter the determined travelling time extension (by rounding up the determined extension value) into the parameter "Travelling time extension for upward travel" on parameter page "Ax – General" (x = number of output).

Presetting the switchover time for movement direction changes

- Set the parameter "Change-over time for travel direction changes" on parameter page "Ax - Time Settings" (x = number of output) to the required change-over interval.
- i** When the actuator is delivered ex factory, the change-over time is generally preset to 1 s.

Computing the curtain height or the louver position

The shutter actuator has a comfortable and accurate positioning function. The actuator calculates the current position of the connected blind, shutter, awning or louver whenever these elements are adjusted either by manual or bus control. The calculated position value is a measure of the height of the blind or of the opening width of the venting louver (Figure 11).

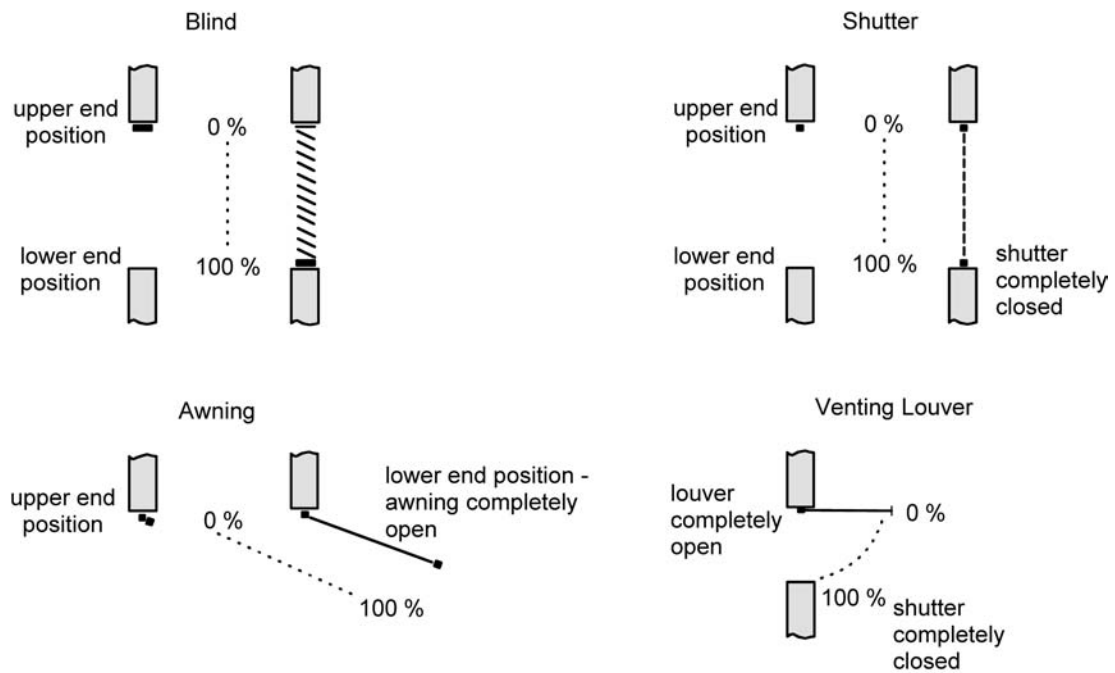

Figure 11: Positions defined as a function of the type of movement

The blinds actuator derives the positions from the configured travelling time since conventional drives do not provide feedback about their positions. Thus, the travelling time separately parameterized for each shutter output is the reference for all position approaches and of basic importance for the accuracy of the position calculations. For this reason, the travelling times should be determined with great accuracy in order to achieve the best possible positioning results.

For positioning purposes, the actuator calculates the movement time required as a function of the current position.

Example 1...

The roller shutter connected to the certain output has an overall travelling time of 20 s. The roller shutter is in its upper end position (0 %). It is to be positioned at 25 %. The actuator calculates the movement time required for approaching the desired position:

$20 \text{ s} \times 0.25_{(25\%)} = 5 \text{ s}$. The output will then lower the roller shutter for 5 s and thus position the blind at height of 25 %.

Example 2...

The roller shutter connected to the certain output has an overall travelling time of 20 s. The shutter is in the 25 % position. It is to be positioned at 75 %. The difference between the positions is 50 %. The actuator calculates the travelling time required for bridging the difference between the positions: $20 \text{ s} \times 0.5_{(50\%)} = 10 \text{ s}$. The output will then lower the roller shutter for 10 s and thus position the blind at height of 75 %.

With all the upward movements, the configured movement time extension is automatically added to the calculated movement time.

Example 3...

The shutter connected to the certain output has an overall travelling time of 20 s. The shutter is in the 75 % position. It is to be positioned at 25 %. The difference between the positions is 50 %. The actuator calculates the unextended movement time required for bridging the difference between the positions:

$20 \text{ s} \times 0.5_{(50\%)} = 10 \text{ s}$. Taking the movement time extension into account (e.g. 10 %), the actual raising time is: $10 \text{ s} \times ((100\% + 10\%_{(\text{extension})}) : 100\%) = 10 \text{ s} \times 1.1 = 11 \text{ s}$. The output will then raise the roller shutter for 11 s and thus position it at a blind height of 25 %.

When the lower or upper end positions (0 % or 100 %) are approached, the movement time is always 20 % longer than the overall movement time.

Example 4...

The shutter connected to the certain output has an overall travelling time of 20 s. The shutter is

in the 75 % position It is to be positioned at 100 %. The difference between the positions is 50 %. The actuator calculates the movement time required for bridging the difference between the positions: $20 \text{ s} \times 0.5_{(50 \%)} = 10 \text{ s}$. As the movement is a limit position movement, the actuator adds 20 % of the total movement time:

$10 \text{ s} + (20 \% : 100 \%) \cdot 20 \text{ s} = 14 \text{ s}$. The output will then lower the roller shutter for 14 s and thus positions it safely at a blind height of 100 %.

Example 5:

The shutter connected to the certain output has an overall travelling time of 20 s. The shutter is in the 50 % position It is to be positioned at 0 %. The difference between the positions is 50 %.

The actuator calculates the unextended movement time required for bridging the difference between the positions: $20 \text{ s} \times 0.5_{(50 \%)} = 10 \text{ s}$. As the movement is a limit position movement, the actuator also adds 20 % of the total movement time: $10 \text{ s} + (20 \% : 100 \%) \cdot 20 \text{ s} = 14 \text{ s}$.

Taking the movement time extension into account (e.g. 10 %), the actual raising time is:

$10 \text{ s} \times ((100 \% + 10 \%_{(\text{extension})}) : 100 \%) = 10 \text{ s} \times 1.1 = 15.4 \text{ s}$. The output will then raise the roller shutter for 15.4 s and thus position safely at 0 %.

- i** The shutter actuator executes position approaches only if a new position deviating from the current position is preset.
- i** The shutter actuator stores the blind/shutter/awning or louver positions temporarily. The shutter actuator can approach newly preset blind/shutter/awning or louver positions only if the current positions are known. For this purpose, each output must be given the opportunity to synchronise itself whenever the supply voltage is switched on or after every ETS programming operation (physical address, application program, partial download). Synchronisation is performed with the help of a reference movement (cf. "reference movement").
- i** Position approaches in progress will be aborted in case of bus or supply voltage failure. In case of bus voltage failure, the configured behaviour will be executed. In case of supply voltage failure, the drives stop. Position approaches are also interrupted when the manual control mode is activated.

Calculating the slat position (only with blinds)

In the "blinds" operating mode, the shutter actuator always calculates the slat position so that the opening angle and thus the amount of light admitted into the room by the blind can be adjusted. A new position approach by a Venetian blind will always be followed by a positioning movement of the slats. Thus, the slat positions last selected will be tracked or readjusted to a new value if a position change has taken place.

In case of single-motor Venetian blind systems without a working position, the slats will be readjusted directly by a change of the Venetian blind height. For this reason, an adjustment of the slat position will always have an influence on the position of the Venetian blind itself (Figure 12).

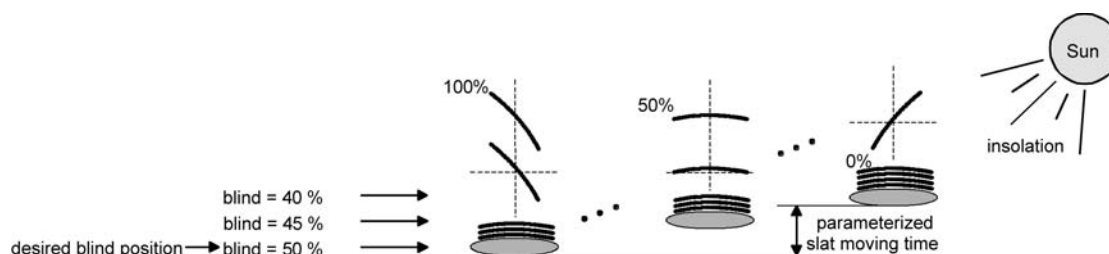

Figure 12: Example of slat positioning affecting the position of the Venetian blind (typical of slat type 1; analogous reaction for type 2)

Since a preset slat position is to remain constant until the next change, the actuator will not change the height of the Venetian blind, if the calculated movement time required for a change of position lies within the configured slat moving time.

Similarly, the actuator accounts for the ratio of the moving times of slat and Venetian blind and – in case of slat position changes – always recalculates the resulting Venetian blind position. If the position feedback objects are used (cf. "Position feedback"), the actuator transmits the blind positions changed by the adaptation also to the bus.

Example (Figure 12)...

The Venetian blind position is preset to 50 %. A change of the slat angle (100 %...0 %) initiates the calculation of a new Venetian blind position which is also tracked in the position feedback objects. If the actuator is to approach a new blind position of, let's say 47 % in this case, the actuator will not perform a travel movement as the calculated travelling time lies within the parameterized slat moving time and therefore coincides with the slat movement. A change of the Venetian blind position to 55 % in this case triggers a Venetian blind movement as the change does not lie within the slat movement (0 to 100 %).

In each position operation, the Venetian blind setpoint position refers to a slat position of 100 %. In the event of a slat repositioning movement (0 to 100 %), the system will therefore report a Venetian blind position below the desired position.

Exception: The Venetian blind setpoint position of 0 % (upper end position) is assigned to the slat position of 0 %. The readjustment of the slat position will result also in this case in a change of the Venetian blind height (brief downward movement). Only in this case will the actuator report back a Venetian blind position above the Venetian blind setpoint position (Figure 13). With slat type 1, the slats are generally horizontal when the Venetian blind is in its upper end position. For this reason, the calculated slat position with a slat type 1 corresponds to the actual opening angle only after the first slat is completely extended (100%).

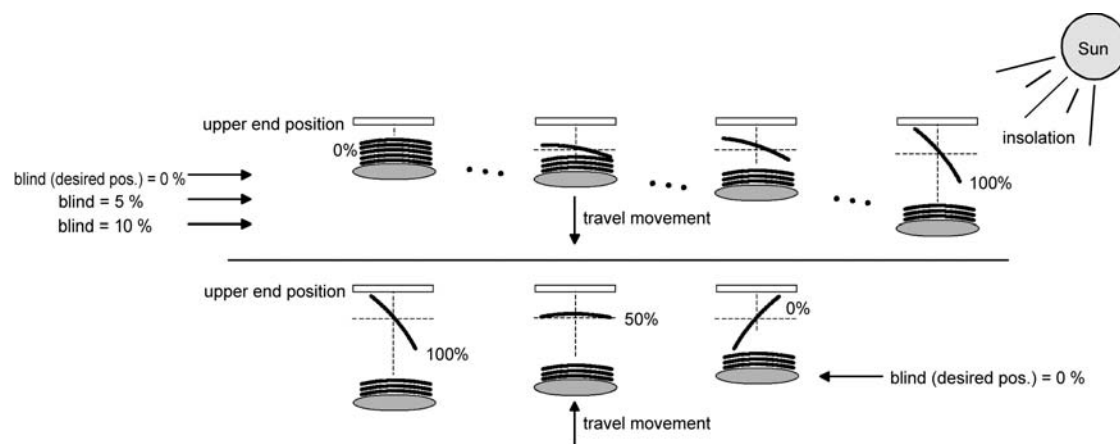

Figure 13: Example of slat positioning with the Venetian blind in upper end position (typical of slat type 1)

Example (Figure 13)...

The Venetian blind position is preset to 0 %. After an extended movement, the Venetian blind is safely in the upper end position. A change of the slat angle (0 %...100 %) initiates the calculation of a new Venetian blind position which is also tracked in the position feedback objects. If the actuator is to approach a new blind position of, let's say 5 % in this case, the actuator will not perform a travel movement as the calculated travelling time lies within the parameterized slat moving time and therefore coincides with the slat movement. A change of the Venetian blind position to 15 % in this case triggers a Venetian blind movement as the change does not lie within the slat movement (0 to 100 %).

- i** The shutter actuator executes slat position adjustments only if a new position deviating from the current slat position is preset.
- i** The shutter actuator stores the slat positions temporarily. The actuator can approach newly preset slat positions only if the current position is known. For this purpose, each output must be given the opportunity to synchronise itself whenever the bus and supply voltage is switched on or after every ETS programming operation (physical address, application program, partial download). The synchronisation is performed with the help of a reference movement for the slat or the Venetian blind (cf. "reference movement").

- i** A change of the Venetian blind height will always result in a change of the slat position. After reactivation of the supply voltage of after ETS programming, the actuator will in this case generally move the slats into the 100 % position, if no position has been preset for the slats.
- i** The smaller the ratio between slat moving time and Venetian blind travelling time, the more precise the position approaches and the less marked the influence of the slat angle adjustment on the height of the Venetian blind.

Reference movement

After ETS programming (physical address, application program, partial download) or after bus and supply voltage failure, all current position data are unknown. Before the actuator can approach new positions after bus and supply voltage return or after programming, the positioning system must at first be calibrated. A position calibration is possible by executing the reference movement.

A reference movement is the time required for a movement into the upper end position increased by 20 % and additionally by the configured movement time extension (Figure 14). A reference movement is not retriggerable.

Reference movements can be executed by the following commands...

- Uninterrupted long time operation (including also a terminated safety movement) into the upper end position activated via the corresponding communication object,
- an approach of the 0 % position,
- a manually controlled movement into the upper end position.

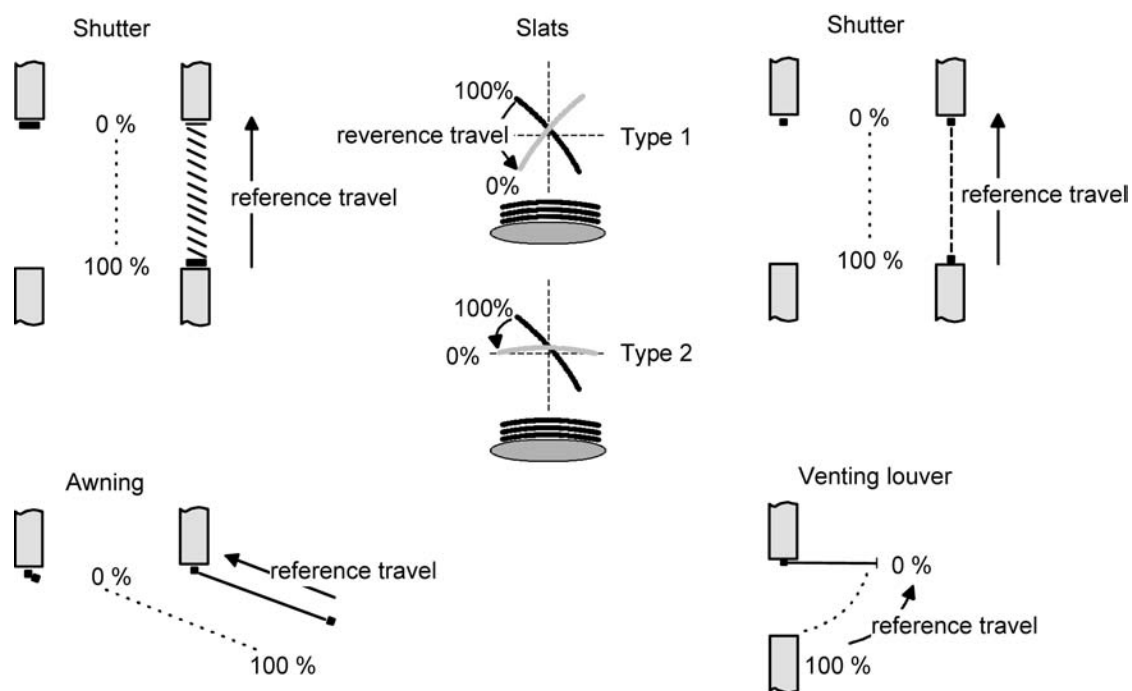

Figure 14: Reference movement

In the event of slat positioning via the corresponding communication objects after bus and supply voltage return or after programming, a slat reference movement becomes necessary if the blind has not been moved beforehand in the up or down directions for at least the parameterized slat moving time. During a slat reference movement, the actuator always moves the slats for the parameterized slat moving time into the completely open position (0 %) and then to the desired position. The slat position is also considered as calibrated when the Venetian blind has been moved by a long-time command in the up or down direction during at least the configured slat moving time.

- i** A terminated reference movement of the Venetian blind will also calibrate the slat position.

- i** If the reference movement is interrupted for instance by a short-time operation, the position is still unknown as before.
- i** A long-time travel into the lower end position activated via the corresponding communication object also calibrates the reference position.
- i** With the sun protection function it is moreover possible to force the actuator to perform a reference movement before each sun protection travel even if the positions are known. Thus, it is ensured that in case of sun protection the configured sun protection position is always precisely approached even after repeated position approaches.
- i** Using the connected drives frequently for position approaches (for instance several times a day) can result after some time in positioning inaccuracies. These deviations from the setpoint position are mostly due to external physical influences. To achieve accurate positioning in operation it is recommended to perform the reference movement at least once every day. This can be achieved for instance by a central raising command transmitted to the long-time object.

Presetting the position

The following ways of presetting positions can be distinguished...

- Direct positioning via the positioning objects (direct operation),
- Positioning by activating the sun protection function,
- Position through the behaviour after bus voltage failure or bus or supply voltage return,
- Positioning by a scene recall.

Positioning via the positioning objects:

Each Venetian blind, roller shutter, awning or venting louvre can be positioned directly using the "Position ..." object, which is separate for each output. An independent positioning object exists for each of the slats. The position approached is always the position last received. The actuator does not show a reaction when the set or to be approached position value is received several times in succession.

This type of control is termed 'direct operation' just like operation via short time, long time or central objects or a scene recall. Positioning via the objects therefore has the same priority. A position movement caused by the communication objects can be interrupted at any time by a long time command, short time command, central command or a scene recall. The direct operation can be overridden by a function with a higher priority, e.g. manual control, forced position, safety or also sun protection (configurable).

The position telegrams must correspond to the 1 byte data format according to KNX datapoint type 5.001 (Scaling). The Venetian blind actuator converts the value received (0...255) linearly into a position (0...100 %) (see the following table).

Received value (0...255)	Position derived from value (0...100 %)
0	0 % (upper end position / slat or venting louvre opened)
↓	↓ (all intermediate values rounded off to 1 % increments)
255	100 % lower end position / slat or louvre closed)

Data format of positioning objects with conversion into percentage position values

It is possible that new positioning telegrams are being received while a position approach is in progress. In this case, the actuator immediately reverses the direction of travel, if the new position to be approached lies in the opposite direction.

If a slat positioning command is received during a running Venetian blind position approach, the device finishes first the Venetian blind position approach before positioning the slat. If a blind positioning command is received during a slat positioning movement, the actuator interrupts the slat positioning movement and approaches the new blind position. Only then does the actuator switch to the most recently received slat position.

In case of Venetian blind positioning, slat positioning will always be executed later. After switching on the bus and supply voltage of the actuator or after programming with the ETS, it may be the case that the slat position is unknown, if no long-time command for the upward or

downward travel with a duration of at least the configured slat moving time has been received or no slat positioning has taken place (no slat reference movement). In this case, the slat is moved during a Venetian blind position approach into the completely closed position (100 %). The slat position is then considered as calibrated.

- i** Optionally, the sun protection function offers the possibility of receiving the instruction of the blind height, venting louvre or slat position to be adopted during sunshine via separate communication objects and to preset these values variably. This form of variable position preset in the sun protection function is identical to presetting the positions via communication objects in direct operation. The priority of the incoming telegrams in direct operation with the sun protection activated can be additionally configured in the ETS.

Position through the sun protection function, the behaviour after bus voltage failure or bus or supply voltage return, or by a scene recall:

With the named functions of the Venetian blind actuator, the positions to be approached are configured directly in the ETS, depending on the operating mode set. The position values can be specified between 0 % and 100 % in 1 % increments.

With Venetian blinds, the height of the Venetian blind is positioned first in these cases. The configured slat position is adjusted only thereafter.

- i** Important notes for all positioning movements: Using the connected drives frequently for position approaches (for instance several times a day) can result after some time in positioning inaccuracies. These deviations from the setpoint position are mostly due to external physical influences. To achieve accurate positioning in operation it is recommended to perform the reference movement at least once every day. This can be achieved for instance by a central raising command transmitted to the long time object.

Position feedback messages

In addition to presetting positions via positioning objects, the shutter actuator can track the current positions values via separate feedback objects and also transmit them to the bus, if the bus voltage is on. Thus, the preset setpoint position can be distinguished from the true actual position of the drives activated.

The following feedback telegrams can be preset for each output depending on the parameterized mode of operation...

- Feedback (1 byte) of the Venetian blind, roller shutter, awning or venting louvre position,
- Feedback (1 byte) of the slat position (only with Venetian blinds).

The individual position feedback messages can be enabled in the ETS independent of one another and have communication objects of their own.

For each travel movement the actuator calculates the current position and tracks it in the position feedback objects. The positions are tracked and the feedback objects updated even when an output has been activated via short-time or long-time telegrams or by manual control on condition that the bus voltage is on.

The feedback objects are updated after the following events...

- At the end of a drive movement – including a slat positioning movement in a Venetian blind – when the drive stops and when the new position is reached,
- With a movement to an end position already at the time the end position is theoretically reached, i.e. before the 20 % extension and the movement time extension have elapsed.

The feedback objects are not updated, if the position last reported back has not changed after a movement (for instance, when the Venetian blind is repositioned, the unchanged slat position will not be reported back a second time).

The shutter actuator cannot calculate a feedback position, if the current position data after switch-on of the bus and supply voltage or after ETS programming are still unknown. In these cases, the actuator must first perform a reference travel (cf. "Reference travel") so that the position can be calibrated. In case of unknown positions, the actuator automatically performs

reference travels, if new positions are preset and if these positions are to be approached. As long as a position is unknown, the value of the feedback objects is "0".

Presetting position feedback for Venetian blind, roller shutter, awning or venting louver positions

The feedback functions can be enabled and programmed independently for each output. When feedback is enabled, the ETS adapts the parameter texts depending on the preset operating mode ("Venetian blind position feedback", "Roller shutter/awning position feedback" or "Venting louver position feedback"). The feedback can be used as an active message object or as a passive status object. As an active signalling object, the position feedback information is transmitted to the bus whenever a position value changes. As a passive status object, there is no telegram transmission after a change. In this case, the object value must be read out. The ETS automatically sets the object communication flags required for proper functioning.

In case of an actively transmitting signalling object, the current position can be transmitted to the bus after bus voltage return, if the position value differs from the one last transmitted. When the position data are known, the feedback telegram can in this case be transmitted with a time delay to reduce the bus load, with the delay being preset globally for all outputs in common (cf. "Delay after bus voltage return").

The feedback functions of an output must be enabled on parameter page "Ax – Enabled functions" (x = number of output). Only then are the parameters for the feedback functions visible.

- Set the parameter "Blind position feedback", "Shutter/awning position feedback" or "Venting louver position feedback" on parameter page "Ax – Feedbacks" to "feedback object is active signalling object".

The feedback object is enabled. The position value is transmitted as soon as it changes. No value will be actively transmitted, if the position is unknown.

- Set the parameter "Venetian blind position feedback", "Roller shutter/awning position feedback" or "Rückmeldung Lüftungskappenposition" on parameter page "Ax - Feedbacks" to "feedback object is passive status object".

The feedback object is enabled. The position value will be transmitted in response only if the feedback object is read out from by the bus. If the position is unknown, a value of "0" will be reported back after readout.

The feedback must be set as actively transmitting.

- If a time delay after bus voltage return should be necessary, the parameter "Time delay for feedback after bus voltage return" on parameter page "Ax – Feedbacks" must be set to "yes"

The position feedback will be transmitted with a delay after bus voltage return. After the end of the time delay, the position last adjusted statically will be transmitted to the bus. No feedback telegram is transmitted during a running delay, even if a position value changes during this delay.

Presetting the position feedback for slat positions (only with Venetian blinds)

The feedback functions for the slat positions can be enabled and programmed independently for each output. As with the position feedback of the Venetian blind height, the feedback can be used as an active message object or as a passive status object.

In case of an actively transmitting signalling object, the current slat position can be transmitted to the bus after bus voltage return, if the position value differs from the one last transmitted. When the position data are known, the feedback telegram can in this case be transmitted with a time delay to reduce the bus load, with the delay being preset globally for all outputs in common (cf. "Delay after bus voltage return").

The feedback functions of an output must be enabled on parameter page "Ax – Enabled functions" (x = number of output). Only then are the parameters for the slat position feedback functions visible.

- Set the parameter "Slat position feedback" on parameter page "Ax – Feedbacks" to "feedback object is active signalling object".

The feedback object is enabled. The position value is transmitted as soon as it changes. No value will be actively transmitted, if the position is unknown.

- Set the parameter "Slat position feedback" on parameter page "Ax – Feedbacks" to "feedback object is passive status object".

The feedback object is enabled. The position value will be transmitted in response only if the feedback object is read out from by the bus. If the position is unknown, a value of "0" will be reported back after readout.

The feedback must be set as actively transmitting.

- If a time delay after bus voltage return should be necessary, the parameter "Time delay for feedback after bus voltage return" on parameter page "Ax – Feedbacks" must be set to "yes"

The position feedback will be transmitted with a delay after bus voltage return. After the end of the time delay, the position last adjusted statically will be transmitted to the bus. During a running delay the affected feedback object is updated but no feedback is transmitted actively, even if a position value changes during this delay.

- i** Behaviour of the position feedback on voltage failure & return:
When bus voltage returns and the external supply voltage of the actuator is on, the current position data is always written to the feedback objects. The positions are transmitted to the bus also in those cases where the feedback objects are actively transmitting objects and where the position data differ from the data last reported back, for instance, as a result of manual control. If the position data is unknown, the feedback objects are initialised with "0" and not transmitted to the bus.

Without external supply voltage the connected drives are not activated, which means that position feedback never takes place, even if bus voltage returns. In case of supply voltage return, the configured behaviour will be executed. The feedback objects are then updated provided the bus voltage is on.

- i** In case of Venetian blind operation, any position change of the Venetian blind within the limits of the slat adjustment (0 to 100 %) does not launch a movement and therefore no change of the feedback position data either.

'Unknown position' feedback and travel movement

In addition to position data feedback, the shutter actuator can also report back enlarged 1-bit status information messages and transmit them actively to the bus, if the bus voltage is on.

The following status feedback messages can be separately preset for each output...

- Feedback of an invalid position,
- Drive movement feedback,

Feedback of an invalid position:

After switch-on of the bus and supply voltage or after programming with the ETS, all the position data of an output is unknown. In this case – when the bus voltage is on – the shutter actuator can update the feedback object "Invalid position"(object value "1") which will then signal that the object values of the 1-byte position feedback objects are invalid.

An invalid position feedback will be only be reversed (object value "0") after the position data for the Venetian blind, roller shutter, awning or venting louver have been calibrated by means of a reference movement. The calibration of the slat position in a Venetian blind alone will not result in the reversal of an 'invalid position' status message.

As an option, the object value of the status feedback message can be actively transmitted to the bus in case of a value change.

Drive movement feedback:

The shutter actuator can report back via a separate 1-bit communication object per output whether the connected drive is moving, i.e. whether the output is supplying current for any of the travel directions. The feedback object has a value of "1" when current is flowing from the output to the drive. Likewise, a "0" is written into the object if the output concerned remains in a stop position. In this case, the operation by which the output was activated (short-time or long-time operation, positioning, manual control, etc.) is of no importance.

As an option, the object value of the status feedback message can be actively transmitted to the bus in case of a value change.

A supply voltage failure in the blinds actuator always results in a "0" being written into the "Travel movement" feedback object. Moreover, the state of the feedback is only derived from

the relay state of the actuator. This means that if a drive is blocked or already in its end position, the value reported back does not correspond to the actual state of the drive movement.

Setting feedback of an invalid position

The feedback of an invalid position can be enabled and programmed independently for each output. When feedback is enabled, the ETS adapts the parameter texts depending on the preset operating mode ("Invalid Venetian blind position feedback", "Invalid roller shutter/awning position feedback" or "Invalid venting louver position feedback"). The feedback can be used as an active message object or as a passive status object. As an active signalling object, the status feedback information is transmitted to the bus whenever a position value changes. As a passive status object, there is no telegram transmission after a change. In this case, the object value must be read out. The ETS automatically sets the object communication flags required for proper functioning.

If the object is an actively transmitting signalling object, the feedback telegram can be transmitted after bus voltage return with a time delay to reduce the bus load, with the delay being preset globally for all outputs in common (cf. "Delay after bus voltage return").

The feedback functions of an output must be enabled on parameter page "Ax – Enabled functions" (x = number of output). Only then are the parameters for the feedback functions visible.

- Set the parameter "Invalid blind position feedback", "Invalid shutter/awning position feedback" or "invalid venting louver position feedback" on parameter page "Ax – Feedbacks" to "feedback object is active signalling object"

The feedback object is enabled. A telegram is transmitted as soon as there is a change (e.g. after ETS programming, after switch-on of the bus and supply voltage or after a reference movement).

- Set the parameter "Invalid blind position feedback", "Invalid shutter/awning position feedback" or "invalid venting louver position feedback" on parameter page "Ax – Feedbacks" to "feedback object is passive status object".

The feedback object is enabled. A telegram will be transmitted in response only if the feedback object is read out by the bus.

The feedback must be set as actively transmitting.

- If a time delay after bus voltage return should be necessary, the parameter "Time delay for feedback after bus voltage return" on parameter page "Ax – Feedbacks" must be set to "yes"

The feedback of an invalid position will be transmitted with a delay after bus voltage return. After the end of the time delay, the object value state last adjusted will be transmitted to the bus. No feedback telegram is transmitted during a running delay, even if a position value becomes known during this delay, for example through a reference movement.

- i Automatic transmission after bus voltage return only takes place if there has been an internal change to the object state (for example through a reference run during manual operation).

Setting drive movement feedback

The feedback of a drive movement can be enabled and programmed independently for each output. The feedback can be used as an active message object or as a passive status object. As an active signalling object, the status feedback information is transmitted to the bus whenever a position value changes. As a passive status object, there is no telegram transmission after a change. In this case, the object value must be read out. The ETS automatically sets the object communication flags required for proper functioning.

If the object is an actively transmitting signalling object, the feedback telegram can be transmitted after bus voltage return with a time delay to reduce the bus load, with the delay being preset globally for all outputs in common (cf. "Delay after bus voltage return").

The feedback functions of an output must be enabled on parameter page "Ax – Enabled functions" (x = number of output). Only then are the parameters for the feedback functions visible.

- Set the parameter "Travel movement feedback" on parameter page "Ax – Feedbacks" to "feedback object is active signalling object".

The feedback object is enabled. A telegram is transmitted when the connected drive starts moving or stops.

- Set the parameter "Travel movement feedback" on parameter page "Ax – Feedbacks" to "feedback object is passive status object".

The feedback object is enabled. A telegram representing the current travel movement will be transmitted in response only if the feedback object is read out by the bus.

The feedback must be set as actively transmitting.

- If a time delay after bus voltage return should be necessary, the parameter "Time delay for feedback after bus voltage return" on parameter page "Ax – Feedbacks" must be set to "yes"

The feedback of a drive movement is transmitted after a delay on bus voltage return, for example, when the drive starts moving on account of the set behaviour after bus voltage return. After the end of the time delay, the object value state last adjusted will be transmitted to the bus. No feedback telegram is transmitted during a running delay, even if the drive stops or starts moving.

- i** Automatic transmission only takes place after a bus voltage return when the drive starts moving on bus voltage return or if the bus failure has caused a change to the drive movement.

Safety function

The blinds actuator can handle up to five different safety functions:

3 x wind alarm, 1 x rain alarm, 1 x frost alarm. Each safety function has a communication object of its own so that the functions can be activated or deactivated independently of one another.

The safety functions are programmed and configured for all shutter/blind outputs together (cf. chapter "Description of channel-independent functions – Safety functions").

The different outputs of the actuator can be separately assigned to all or to individual safety functions. Only assigned outputs respond to a change in the state of the safety objects. The reactions at the beginning of an alarm ("1" telegram) can be parameterized for each alarm separately whereas the reaction at the end of an alarm ("0" telegram) can be parameterized for all alarms in common .

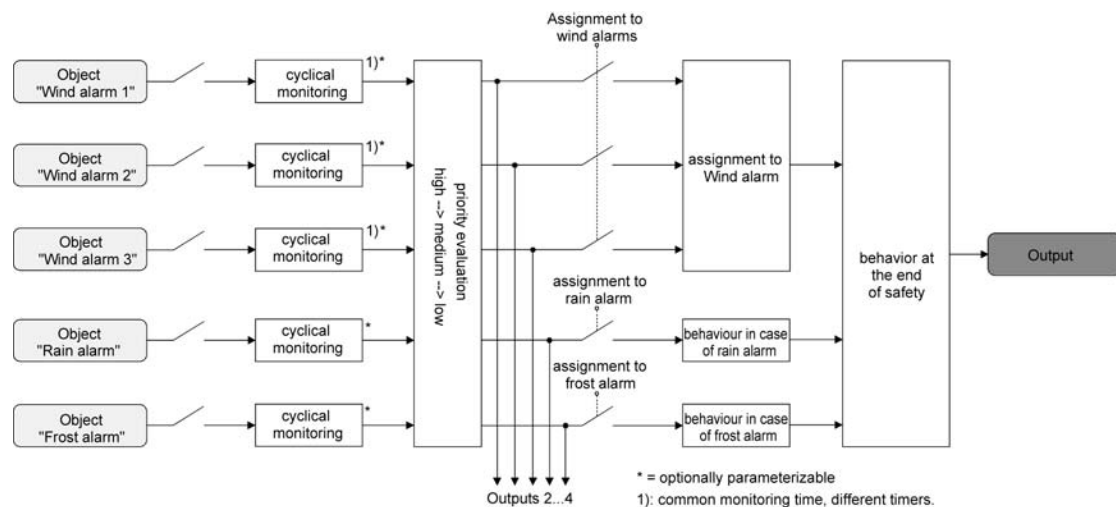

Figure 15: Function diagram of channel-oriented safety functions

An output can be assigned independently to the wind alarms, the rain alarm and the frost alarm. If an output is associated with several alarms, the preset priority decides which of the alarms will prevail and be executed. In so doing, an alarm with a higher priority overrides the alarms with the lower priorities. When safety alarm with the higher priority has ended, the safety alarm with the lower priority is executed on condition that it is active.

The order of priority of the wind alarms with respect to the frost alarm or to the rain alarm can be configured for several channels on the parameter page "Safety". The three wind alarms have the same priority with respect to one another (logic OR). The last telegram update to the wind

alarm objects decides which of the wind alarms will be executed. The wind alarm is completely deactivated only after all three objects are inactive ("0").

An output in the active safety alarm state is locked, i.e. the control of the output concerned via the bus by direct operation (short-time, long-time telegram, scenes, positioning, central) or by a sun protection function is prevented. Only a forced position and a manual control locally on the device itself have a higher priority so that these functions may override a safety interlock. At the end of a forced position or of a manual control, the safety reaction is re-executed if an assigned safety alarm is still active.

Assigning safety alarms

The individual safety alarms can be assigned separately for each output. The channels are assigned on parameter page "Ax – Safety" (x = number of output).

The safety functions must be globally enabled on the "Safety" parameter page before the output assignments are configured.

The safety function for an output must be enabled on parameter page "Ax – Enabled functions (x = number of output). Only then are the channel-related parameters for the safety function visible.

- If an assignment to the wind alarms is necessary, set the parameter "Assignment to wind alarms" to the wind alarm or the wind alarms required.

The output is assigned to the specified wind alarms.

- If an assignment to the rain alarm is necessary, set the parameter "Assignment to rain alarm" to "yes".

The output is assigned to the rain alarm.

- If an assignment to the frost alarm is necessary, set the parameter "Assignment to frost alarm" to "yes".

The output is assigned to the frost alarm.

- i** If an output is assigned to an alarm which is not globally enabled, the assignment is without effect.
- i** Important information about the activation or deactivation of a safety alarm, about the presetting of the priority and about cyclical monitoring can be found in chapter "Channel-independent functional description – Safety functions".

Presetting the behaviour at the beginning of a safety alarm

The behaviour of an output at the beginning of a safety alarm can be parameterized separately for each alarm (wind alarms in common, rain and frost alarms separately). The alarm behaviour is preset on parameter page "Ax – Safety" (x = number of output). At the beginning of a safety alarm, the actuator locks the outputs concerned, i.e. control via the bus by direct operation (short time, long time telegram, scenes, positioning) or by a sun protection function is prevented.

Depending on the selected operating mode, the ETS adapts the designations of the parameter settings ("raising" ↔ "opening the louver" / "lowering" ↔ "closing the louver").

The safety functions must be globally enabled on the "Safety" parameter page.

The safety function for an output must be enabled on parameter page "Ax – Enabled functions (x = number of output). Only then are the channel-related parameters for the safety function visible.

The behaviour in case of a safety alarm can only be adjusted, if the output concerned has been assigned to the corresponding alarm. Since there is no difference between the alarm-dependent configurations, the selection of the parameters is described below only once.

- Set the parameter "Behaviour in case of ..." to "no reaction".
At the beginning of the alarm, the output is locked and the relay of the output shows no reaction. Any movements still in progress at this instant will still be completely finished.
- Set the parameter "Behaviour in case of ..." to "raising" or "opening the louver".
The actuator raises the curtain or opens the venting louver at the beginning of the alarm and locks the output thereafter.
- Set the parameter "Behaviour in case of ..." to "lowering" or "closing the louver".

The actuator lowers the curtain or closes the venting louver at the beginning of the alarm and locks the output thereafter.

- Set the parameter "Behaviour in case of ..." to "stop".

At the beginning of the alarm, the actuator switches the relays of the output to "stop" and locks the output. A drive movement, if any, will be interrupted.

- i** The safety movement time required by an output to move the drive into the end positions is determined by the "Movement time" parameter on parameter page "Ax - Times". Like the long-time operation, a safety movement is derived from the movement time. Downward movement: movement time + 20 %; Upward movement: movement time + 20 % + configured movement time extension. Safety movements are not retriggerable.
- i** Slats of blinds are not repositioned at the end of safety movements to end positions.

Presetting the behaviour at the end of all safety alarms

The shutter actuator ends the safety interlock of an output only after all safety alarms assigned to the output have become inactive. Thereafter, the output concerned shows the parameterized "Behaviour at the end of safety". The behaviour is configured on parameter page "Ax — Safety" (x = number of output) in common for all alarms.

Depending on the selected operating mode, the ETS adapts the designations of the parameter settings ("raising" ↔ "opening the louver" / "lowering" ↔ "closing the louver").

The safety functions must be globally enabled on the "Safety" parameter page.

The safety function for an output must be enabled on parameter page

"Ax – Enabled functions (x = number of output). Only then are the channel-related parameters for the safety function visible.

- Set the parameter "Behaviour at the end of safety" to "no reaction".

At the end of all safety alarms, the output is released and the relay of the output shows no reaction. Any movements still in progress at this instant will still be finished.

- Set the parameter "Behaviour at the end of safety" to "raising" or "opening the louver".

The actuator releases the output at the end of all safety alarms and raises the curtain or opens the venting louver.

- Set the parameter "Behaviour at the end of safety" to "lowering" or "closing the louver".

The actuator releases the output at the end of all safety alarms and lowers or closes the venting louver.

- Set the parameter "Behaviour at the end of safety" to "stop".

At the end of all safety alarms, the output is released and the actuator switches the relays of the output to "stop". A drive movement, if any, will be interrupted.

- Set the parameter "Behaviour at the end of safety" to "tracking the position".

At the end of all safety alarms, the output will be set to the state last adjusted statically before the safety function or to the state tracked and internally stored during the safety function. The position objects, the long time object and the scene function are tracked.

- i** Parameter setting "Position tracking": The shutter actuator can track absolute positions after safety release (position telegram, scene value) only if the position data are known and if the positions have been predefined. In all other cases, no reaction takes place on release of safety.

Position data can be tracked, if the output was in a defined position before the safety function or if a new position telegram was received via the position objects during the safety interlock. In the latter case, a reference movement will be executed when the safety function is enabled, if the position before or during the safety interlock was unknown. Known slat positions will also be tracked as described. This is also the case, when the height of the Venetian blind is unknown.

Long time movements (movements without position preset) will, however, always be tracked.

- i** The preset "Behaviour at the end of safety" will only be executed, if the output passes over to direct operation at the end of all safety alarms. If a sun protection function is activated (independent of the preset priority with respect to direct operation), it will be also executed.

Sun protection function - General information

Each output of the shutter actuator can be separately configured for the execution of a sun protection function. Sun protection is generally realized with blinds, shutters or awnings and offers an intelligent method of shading rooms, terraces or balconies during sunshine depending on the altitude of the sun in the sky and on the intensity of the sunlight (Figure 16)

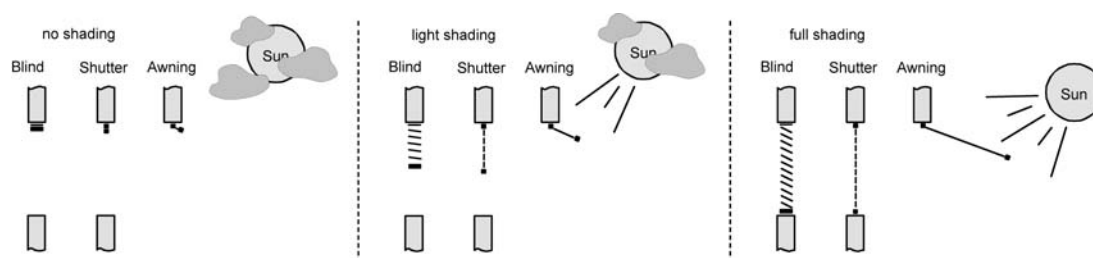

Figure 16: Sun protection principles (example)

The sun protection functions of the shutter actuator can be adapted many different applications. In simple applications as, for instance, in case of direction-dependent measurement of the sun's intensity by means of a brightness sensor, the curtains controlled can be closed partly or completely to prevent being disturbed by direct sunlight. In these applications, the sun protection function merely evaluates the 1-bit sun signal from the brightness or a similar sensor (e.g. weather station with limit value monitoring) and makes a drive open or close the controlled curtains by moving them into fixed configured positions or into variable positions preset via the bus.

In extended applications – for instance where the degree of shading is controlled by weather stations evaluating additionally the sun angle as a function of astro co-ordinates and presetting the blind and also the slat positions dynamically – the sun protection function can be supplemented by an automatic control system. In such applications, the sun protection function evaluates additional bus communication objects allowing to enable or to disable the automatic control while the shutter actuator is in operation. This results in a large number of combination variants with intelligent Venetian blind control systems.

Already simple sun protection applications are sufficient to permit a fixed or variable re-adjustment of the positions of Venetian blind slats for adapting the curtain to individual shading requirements. For such purpose, it is possible to preset a static slat offset in the ETS parameters, for instance, for adapting the reflection of sunlight depending on the building situation, or additionally, a dynamical slat offset via a bus communication object, for instance, for manual re-adjustment of the slat opening by persons in the room or otherwise by a central building services control system.

In all cases, the priority between an incoming sunshine or automatic telegram and the direct operation of an output (short-time, long-time telegram, scenes, positioning, central) can also be preset in the ETS. This way, a sun protection position can, for instance, be influenced by a 'manual' operation of a pushbutton sensor in the room and the sun protection function be interrupted. Alternatively, sun protection mode can therefore not be interrupted by a direct operation, i.e. the output is locked.

A sun protection function can be overridden by a safety function, a forced position or also by a manual control locally on the device itself, as these functions of the blinds actuator invariably have a higher priority. At the end of one of the mentioned functions with a higher priority, the same reaction as the one at the beginning of sun protection will be re-executed, if the sun protection function is still active at this time.

The shutter actuator can be operated with two sun protection functions. The simple sun protection or alternatively the extended sun protection that can be enabled.

Sun protection function - Simple sun protection

In the simple sun protection, shading against sunlight is activated and deactivated via the 1-bit communication object "Sunshine / shading facade". The polarity of this object can be selected in the ETS. The sun protection is activated as soon as "sunshine" is signalled to the object depending on the preset polarity. After ETS programming or after switch-on of the supply

voltage, the object must at first have data written into it by the bus also in case of inverted polarity before the sun protection can be activated.

A newly received object value (sun / beginning of shading or sun / end of shading) can optionally be evaluated with a time delay. This feature permits suppressing brief brightness variations caused, for instance, by passing clouds or by a thunderstorm. An update (from activated to activated) of the "Sunshine / shading facade" object causes the sun protection to be reactivated, if it had been influenced and possibly been re-enabled beforehand by a direct operation in acc. with the preset priority.

The reaction of a specific output at the beginning of shading can be preset in the ETS. Amongst other things, this setting permits approaching fixed configured positions or positions preset via the bus and thus variable. Variable positions for sun protection purposes can be preset, for instance, by means of pushbutton sensors or visualisations. In addition, it is possible in case of a defined sun protection positioning movement to have a reference movement executed by forced control. This ensures that identical blind positions are approached synchronously by different outputs in case of a sun protection positioning movement. The reaction at the end of a shading task can be preset as well. In this situation, the curtain can pass into an end position, be stopped or shown no special reaction. Tracking of positions is possible as well.

By means of a priority setting in the ETS configuration, it can be specified whether the sun protection function can be influenced by direct operation or whether the corresponding output is locked by a telegram "Sunshine / shading facade" in the sun protection position. Basically, the "Manual control", "Forced position" and "Safety" functions have a higher priority so that these functions can override, but not terminate a sun protection. Thus, the sun protection function is re-executed at the end of a function with a higher priority, if the object "Sunshine / shading facade" continues to signal the presence of sunshine.

- i** The following rules must be observed for the extended sun protection: After an ETS programming operation, the sun protection function including automatic operation is always deactivated. Activated sun protection (independent of the selected priority with respect to direct operation) remains active even after a bus voltage failure as long as the supply voltage is still on. The sun protection reaction last executed will therefore be executed again at the end of a temporary or permanent manual control (if enabled in case of bus failure), even if there is no bus voltage.

The schematic diagram of the simple sun protection (Figure 17) and an example of how sensor components can be integrated into a simple sun protection configuration.

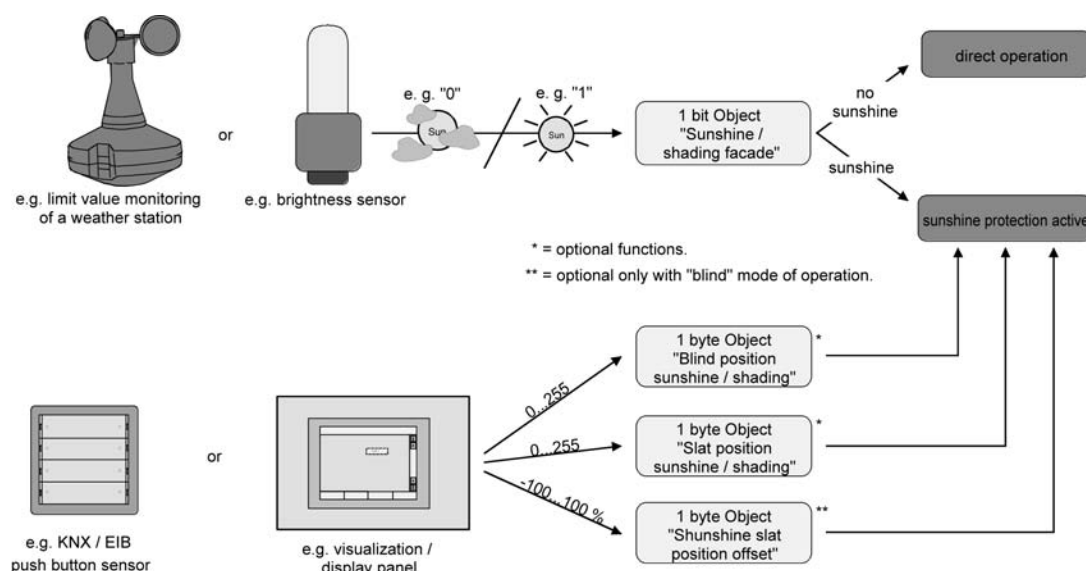

Figure 17: Schematic diagram illustrating the simple sun protection configuration

The function diagram (Figure 18) shows all possible functions of the simple sun protection. For reasons of clarity, the functions with a higher priority (manual control, forced position, safety function) are not shown in the diagram.

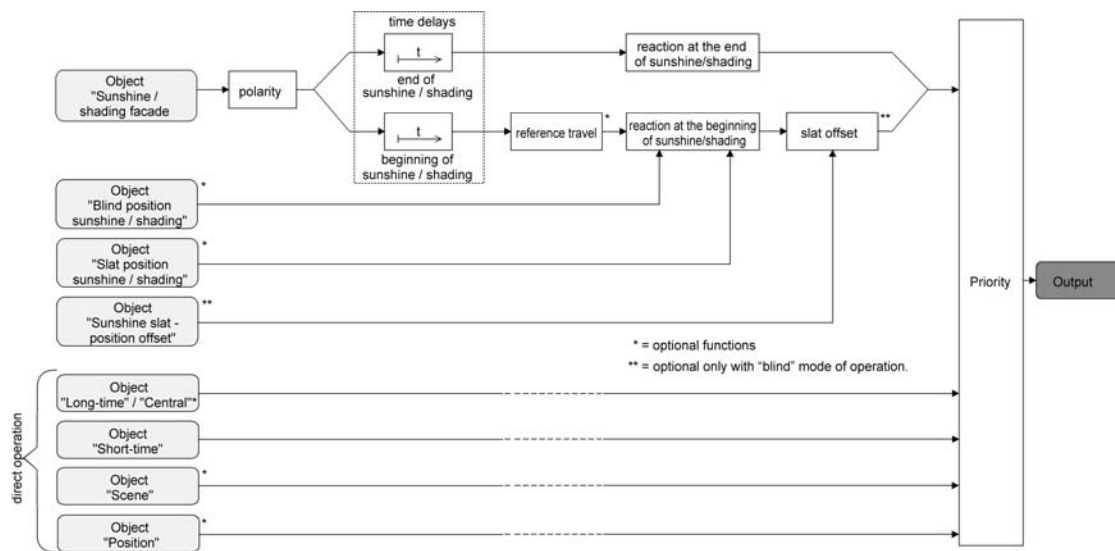

Figure 18: Function diagram illustrating the simple sun protection

Sun protection function - extended sun protection

The extended sun protection has the basic functional properties of the simple sun protection function. In addition, an automatic control system can be implemented. Venetian blind control systems for blind and slat position tracking with respect to the position of the sun as, for instance, a weather station with combination sensor can therefore be integrated into the Venetian blind actuator system via the bus as an added automatic function.

In the extended sun protection, shading against sunlight is activated and deactivated via the 1-bit communication object "Sunshine / shading facade". A reaction of the output to the sun telegram can be expected only after the automatic control has been activated. In all other cases, the sun protection function is completely deactivated.

As far as the activation of the automatic control via the corresponding object is concerned, the following two cases must be distinguished...

- Sun shading action starting immediately:
Automatic operation is activated as soon as the Object 15 "Automatic" receives a "1" telegram. The output reacts immediately to the activation and shows the preset behaviour depending on sunlight conditions (Sun / beginning of the shading action / Sun end of the shading action). The sunlight conditions are derived from the "Sun / shading facade" object according to the set polarity - if necessary after the delays have elapsed.
After an ETS programming operation or after switch-on of the bus and supply voltage, the "Sunshine / shading facade" object is initialised with "0" and, unlike the simple sun protection, evaluated immediately depending on the preset polarity so that shading against sunlight can begin immediately on activation of the automatic sun protection function. The reception of a "0" telegram by the object "Automatic" always terminates an automatic operation independent of the state of the "Sunshine / shading facade" object.

Application example:

Private house with conservatory. The conservatory is equipped with Venetian blinds to shade the place against sunlight. When the conservatory is used, automatic operation is activated, for instance, with a pushbutton sensor on the wall. The Venetian blind actuator then carries out the shading operation immediately if sunshine was previously detected. The actuator then carries out the configured behaviour at the end of Sunshine / Shading, if no sunshine was detected on activating Automatic operation.

- Activation of the sun shading only on the next update:
In this configuration, the polarity of the automatic object can be preset. The automatic operation is activated as soon as object 16 "Automatic" is set to 'active' in consideration of polarity. A reaction at the output occurs, however, only after a new change of state ("0" -> "1" or "1" -> "0") has been signalled via the "Sunshine / shading facade" object. In this case, the new state (beginning of sunshine/shading or end of sunshine/shading) determines the behaviour of the output immediately depending on the preset polarity.
After an ETS programming operation or after switch-on of the bus and supply voltage, the object "Automatic" must at first have data written into it by the bus also in case of inverted polarity before the automatic operation can be activated.
The reception of an 'Automatic deactivated' telegram by the "Automatic" object always terminates an automatic operation independent of the state of the "Sunshine / shading facade" object.

Application example:

An office building is equipped with several Venetian blinds to shade individual offices against sunlight. In the early morning hours, the automatic sun protection is activated in a central place in the building, e.g. in the porter's lodge. The Venetian blinds will, however, not move into the shading positions unless the system has actually reported sunshine for the building facades in question.

The behaviour at the end of automatic operation is configured separately in the ETS and is executed whenever the automatic mode is terminated and when no function with a higher priority is active at this time. In this situation, the curtain can pass into an end position, be stopped or shown no special reaction. Tracking of positions is possible as well.

Disabling functions of the extended sun protection:

In the event of the sun shading action starting immediately, the automatic operation can optionally be disabled with an additional communication object. The objects "Automatic" and "Automatic mode disable" are logically combined (AND with feedback). When disabling is activated, the automatic operation is reset and thus aborted. The output concerned will then show the behaviour at the end of automatic operation. The automatic mode can only be reactivated if the disabling object is released and if object 15 "Automatic" is updated again by writing a "1" into it. Any attempt to activate the automatic mode while a disable is active will be ignored.

Automatic operation disabling example:

An office room is equipped with Venetian blinds to shade the room against sunlight. The room is moreover equipped with a pushbutton sensor on the wall with which the automatic operation can be activated or also deactivated. When the automatic mode is activated, the room is immediately shaded against sunlight, if necessary. Depending on the time of day or in the event of disturbing sunlight falling into the room, the people in the room can therefore decide for themselves whether automatic shading is desired or not.

If required, the automatic sun protection is disabled in a central place of the building, for instance, in the porter's lodge. The automatic control of the Venetian blinds can then be deactivated, if servicing work is being carried out (window cleaning or similar work). After the end of disabling, for instance, at the end of the working hours, automatic operation can only be restarted if it is reactivated in any of the rooms in case of need.

In addition, also the direct operation of an output can be disabled with an independent disabling object. When disabling is active, a direct operation can – independently of the preset priority – never override a sun protection function. In this case, direct operation is non operational in other functions, too. During disabling, incoming direct operation telegrams are completely ignored (positions received via the bus can then not be tracked either).

If the disabling command is received while a movement initiated by direct operation is in progress, the movement will still be completely finished. Thereafter, direct operation is disabled.

Direct operation disabling example:

An office building is equipped with several Venetian blinds to shade individual offices against sunlight. During the working hours, the rooms are to be shaded automatically. Any direct operation – e.g. by means of a simple Venetian blind pushbutton sensor on the wall – is to be disabled during the day. For this reason, the direct operation is disabled, for instance, by the porter or by a building services management system. Cleaners must have the possibility of controlling the shutters directly only after the normal working hours. In this case, direct operation can again be centrally enabled during evening and night hours.

The disabling functions for automatic and for direct operation can also be combined so that it is possible to intervene at any time and as required by the situation in sun protection control functions.

Sunshine signal in the extended sun protection mode:

In the sun protection mode, the system is informed about the prevailing sunshine conditions via the "Sunshine / shading facade" communication object. The system then decides whether shading is required or not. In the extended sun protection mode, the sunshine signal is only evaluated when the automatic operation is activated as well.

A new value received via the "Sunshine / shading facade" object can optionally be evaluated with a time delay. This feature permits suppressing brief brightness variations caused, for instance, by passing clouds or by a thunderstorm. The time delay is started after an update of the "Sunshine / shading facade" object also in those cases where the automatic operation is deactivated so that the newly received information about the sunshine conditions may possibly also be processed with a delay, if the automatic operation is activated later on.

Unlike in the simple sun protection mode, an update of the "Sunshine / shading facade" object from active to active or from inactive to inactive in the extended sun protection mode shows generally no reaction. The behaviour of the output is only influenced if a change of state is being detected. An update of the sunshine signal alone does not result in the activation of the automatic operation either.

When the automatic operation is active, the reaction of a specific output at the beginning of shading can be preset separately in the ETS. This setting permits, amongst other things, approaching fixed configured positions or positions preset via the bus and thus variable. Positions for sun protection purposes can be variably preset, for instance, by means of a weather station for sun position tracking.

In addition, it is possible in case of a defined sun protection positioning movement to have a reference movement executed by forced control. This ensures that identical blind positions are approached synchronously by different outputs in case of a sun protection positioning movement.

The reaction of an output at the end of shading with active automatic operation is also separately parameterizable. In this case, too, it is possible, amongst other things, to approach

fixed configured positions.

By means of a priority setting in the ETS parameters it can be specified whether the evaluation of the sunshine signal in the automatic mode can be influenced by a direct operation or whether the automatic mode basically locks the corresponding output during sun protection. The "Manual control", "Forced position" and "Safety" functions invariably have a higher priority so that these functions can override, but not terminate a sun protection including an automatic operation. Thus, the sun protection function is re-executed at the end of a function with a higher priority, if the automatic sunshine protection is still active.

An update (from activated to activated) of the "Automatic" object causes the sun protection to be reactivated, if it had been influenced and cancelled beforehand by a direct operation in accordance with the lower priority.

The schematic diagram of the extended sun protection (Figure 19) and an example of how sensor components can be integrated into an extended sun protection configuration.

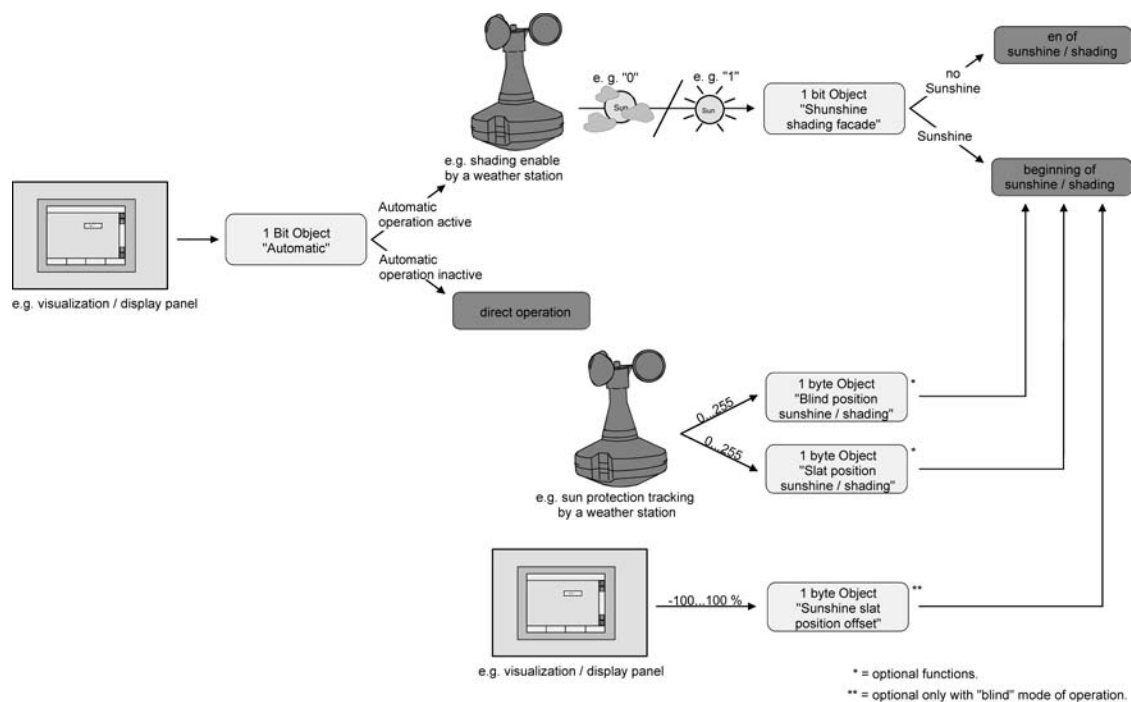

Figure 19: Schematic diagram illustrating the extended sun protection configuration (for reasons of simplicity without disabling functions)

The function diagram (Figure 20) shows all possible functions of the extended sun protection. For reasons of clarity, the functions with a higher priority (manual control, forced position, safety function) are not shown in the diagram.

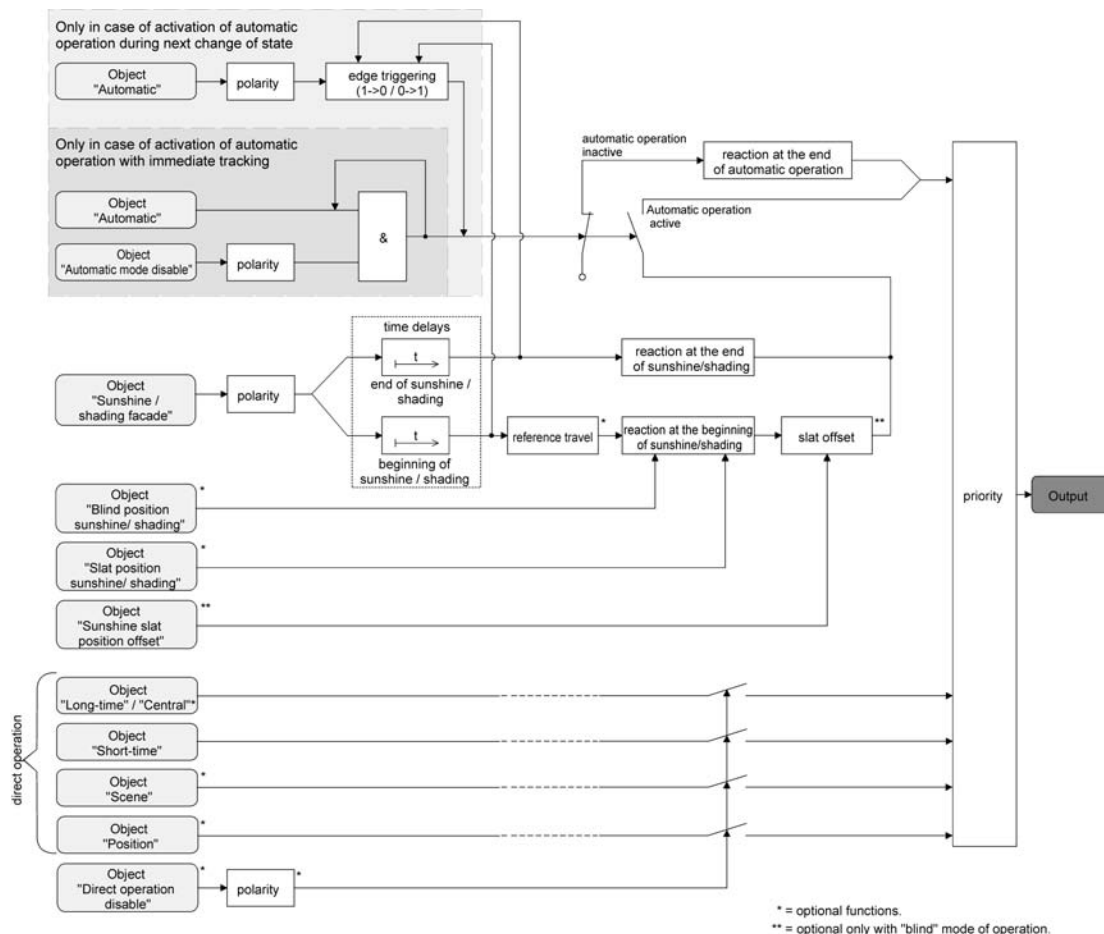

Figure 20: Function diagram illustrating the extended sun protection

- i** The following rules must be observed for the extended sun protection:
 After an ETS programming operation, the sun protection function including automatic operation is always deactivated. Activated sun protection (independent of the selected priority with respect to direct operation) remains active even after a bus voltage failure as long as the external supply voltage is still on. The sun protection reaction last executed will therefore be executed again at the end of a temporary or permanent manual control (if enabled in case of bus failure), even if there is no bus voltage.

Presetting the type of sun protection

The type of sun protection can be preset separately for each output. The setting determines whether the simple or the extended type of sun protection is configured.

For the sun protection parameters to be visible, the sun protection function must be enabled on parameter page "Ax – Enabled functions (x = number of output)".

- Set the parameter "Type of sun protection" on parameter page "Ax – Sun protection" to "simple sun protection".
 Simple sun protection is now configured. The necessary parameters and communication objects are visible.
- Set the parameter "Type of sun protection" on parameter page "Ax – Sun protection" to "enlarged sun protection".
 Extended sun protection is now configured. The necessary parameters and communication objects are visible.

- i** When the sun protection type parameters are changed, the assignments of group addresses to sun protection objects or other parameter settings are lost. For this reason, the sun protection type parameter should be selected directly at the beginning of the sun protection configuration and then not be changed anymore later on.

Presetting the priority of sun protection (for simple sun protection only)

The priority of the sun protection function can be set separately for each output. In the simple sun protection, the priority relations between the "Sunshine / shading facade" object and the objects of direct operation (short-time, long-time, central or position telegram, scene recall) must be configured.

For the sun protection parameters to be visible, the sun protection function must be enabled on parameter page "Ax – Enabled functions (x = number of output)".

The function must have been configured for simple sun protection.

- Set the parameter "Priority of sun protection with respect to direct operation" on parameter page "Ax - Sun protection" to "same priority".

The sun protection mode can be overridden at any time by direct operation. In the same way, the sun protection overrides the direct operation, when a new "sunshine" telegram is received via the "Sunshine / shading facade" object and when a configured time delay, if any, has elapsed. If the sun protection function is overridden by a direct operation, the preset behaviour "Reaction at the end of sunshine / shading" will not be executed.

- Set the parameter "Priority of sun protection with respect to direct operation" on parameter page "Ax - Sun protection" to "higher priority".

An active sun protection will override a direct operation. The sun protection mode can therefore not be interrupted by a direct operation. Direct operation will be possible again only after the sun protection function is terminated.

- Set the parameter "Priority of sun protection with respect to direct operation" on parameter page "Ax - Sun protection" to "lower priority".

A direct operation can at any time override the sun protection mode. If the sun protection function is overridden by a direct operation, the preset behaviour "Reaction at the end of sunshine / shading" will not be executed. The sun protection function can only be reactivated after an enabling movement controlled by a direct operation has been effected and after a new "sunshine" telegram has been received via the "Sunshine / shading facade" object. Attempts to activate the sun protection function are ignored for as long as the enabling movement has not taken place.

On the enabling movement:

An enabling movement is an accomplished long-time movement into the upper end position which has been initiated by the objects "Long time operation" or "Central travel control". A manual control, an upward travel movement after bus voltage failure or bus voltage return, a position approach to "0 %" or an upward travel movement after releasing enabling of forced-position or safety functions have no enabling effect.

The sun protection is not enabled if the enabling movement has been interrupted. The sunshine protection function will be also be disabled if the output has been readjusted again by a direct operation after an accomplished enabling movement.

After an ETS programming operation or switch-on of the bus voltage and supply voltage, the sunshine protection function is always enabled.

- i** Manual local operation on the device itself, the forced position function and the safety functions have a fixed priority higher than that of the sun protection. The sun protection is overridden – but not terminated – by a function with a higher priority. After the end of the function with the higher priority the reaction at the beginning of sun protection will therefore be executed again, if the sun protection is still active at this time.
- i** With the settings "same priority" or "lower priority", the sun protection can be overridden by a direct operation only if the direct control action can be executed at once. A direct operation will therefore not override the sun protection during a manual control locally on the device, an active forced position function or an active safety function.
- i** Parameter setting "same priority" or "lower priority": A variable preset of curtain and slat positions or of a slat offset via the bus at the beginning of sunshine / shading shows no reaction at the output, if the sun protection was overridden by direct operation. However, the position data or offsets received are stored internally so that the new positions will be approached on reactivation of the sun protection.

Presetting the priority of automatic sun protection (for extended sun protection only)

The priority of the automatic sun protection function can be set separately for each output. In the enlarged sun protection, the priority relations between the "Sunshine / shading facade" object and the objects of direct operation (short-time, long-time, central or position telegram, scene recall) must be configured. The selected priority thus affects the evaluation of the sunshine signal in the automatic mode and not the automatic mode itself.

For the sun protection parameters to be visible, the sun protection function must be enabled on parameter page "Ax – Enabled functions (x = number of output)".

The function must have been configured for extended sun protection.

- Set the parameter "Priority of automatic operation with respect to direct operation" on parameter page "Ax - Sun protection" to "same priority".

The sunshine signal of the automatic sun protection mode and the corresponding reaction can be overridden at any time by direct operation. In the same way, the sunshine signal overrides the direct operation, when a new "sunshine" or "no sunshine" telegram is received via the "Sunshine / shading facade" object and when this telegram results in a change of state. Moreover, a configured delay time, if any, must have elapsed. When the sunshine signal is overridden by a direct operation, the preset behaviour "Reaction at the end of sunshine / shading" will not be executed.

- Set the parameter "Priority of automatic operation with respect to direct operation" on parameter page "Ax - Sun protection" to "higher priority".

An active automatic mode always overrides the direct operation independent of the sunshine signal. The sunshine signal can therefore not be interrupted by a direct operation. Direct operation will be possible again only after the automatic mode is terminated.

- Set the parameter "Priority of automatic operation with respect to direct operation" on parameter page "Ax - Sun protection" to "lower priority".

A direct operation can at any time override the sunshine signal. If the sunshine signal is overridden, the preset behaviour "Reaction at the end of sunshine / shading" will not be executed. The sunshine signal will be evaluated again only after an enabling movement controlled by a direct operation has been effected and when a new "sunshine" or "no sunshine" telegram is received via the "Sunshine / shading facade" object and when this telegram results in a change of state. The sun protection function is ignored for as long as the enabling movement has not taken place.

On the enabling movement:

An enabling movement is an accomplished long-time movement into the upper end position which has been initiated by the objects "Long time operation" or "Central travel control". A manual control, an upward travel movement after bus voltage failure or bus voltage return, a position approach to "0 %" or an upward travel movement after releasing enabling of forced-position or safety functions have no enabling effect.

The sunshine signal is not enabled if the enabling movement has been interrupted. The sunshine signal will be also be disabled, if the output has been re-adjusted again by a direct operation after an accomplished enabling movement.

- i** A direct operation never terminates the automatic mode. Irrespective of a function being overridden by a direct operation, an activation or a deactivation of the automatic mode (telegram update of the "Automatic" object) always re-enables the sunshine signal as well and evaluates it when the automatic mode is active. Attention must be paid to this behaviour especially in those cases where the "Automatic" object is cyclically overwritten by telegrams.
- i** Manual local operation on the device, the forced position function and the safety functions have a fixed priority higher than that of the automatic sun protection. The sun protection is overridden – but not terminated – by a function with a higher priority. After the end of the function with the higher priority the reaction last executed by the automatic sun protection will therefore be executed again, if the sun protection is still active at this time.
- i** With the settings "same priority" or "lower priority", the sunshine signal can be overridden by a direct operation only if the direct control action can be executed at once. A direct operation will therefore not override the sunshine signal during a manual control locally on the device, an active forced position function or an active safety function.

- i** Parameter setting "same priority" or "lower priority": A variable preset of blind and slat positions or of a slat offset via the bus at the beginning of sunshine / shading shows no reaction at the output, if the sunshine signal was overridden by direct operation. However, the position data or offsets received are stored internally so that the new positions can be approached when the sensor signals that the sun is shining again.
- i** Irrespective of the preset priority, an update of the "Sunshine / shading facade" object from active to active or from inactive to inactive in the extended sun protection mode shows generally no reaction. The behaviour of the output is only influenced if a change of state is being detected.

Presetting the polarity of the "Sunshine / shading facade" object

The telegram polarity of the "Sunshine / shading facade" object can be preset separately for each output. This means that an adaptation to the signals from existing sensors or weather stations is possible in the simple and also in the extended sun protection mode.

For the sun protection parameters to be visible, the sun protection function must be enabled on parameter page "Ax – Enabled functions (x = number of output).

- Set the parameter "Polarity of 'Sunshine / shading facade' object" on parameter page "Ax - Sun protection" to the required telegram polarity.

The sunshine signal is evaluated in accordance with the preset priority.

- i** In the simple sun protection mode, an update (from activated to activated) of the "Sunshine / shading facade" object causes the sun protection to be reactivated, if it had been influenced and possibly been re-enabled beforehand by a direct operation in acc. with the preset priority.
- i** In the extended sun protection mode, an update of the "Sunshine / shading facade" object from active to active or from inactive to inactive shows generally no reaction. The behaviour of the output is only influenced if a change of state is being detected.

Presetting the activation of the automatic mode (for extended sun protection only)

As far as the activation of the automatic mode is concerned, two cases must be distinguished which can be configured with the help of ETS parameters separately for each output. Either a travel movement in acc. with the reaction at the beginning or the end of sunshine is executed immediately on activation of the automatic mode, or otherwise the system waits after activation of the automatic mode for a new change of state in the "Sunshine / shading facade" object until the corresponding output shows the reaction at the beginning or at the end of sunshine.

For the sun protection parameters to be visible, the sun protection function must be enabled on parameter page "Ax – Enabled functions (x = number of output).

The function must have been configured for extended sun protection.

- Set the parameter "Activation of automatic mode by..." on parameter page "Ax - Sun protection" to "Object 'Automatic' and next change of state".

Automatic operation is activated as soon as the "Automatic" object is set to 'active' in consideration of polarity. A reaction at the output occurs, however, only after a new change of state has been signalled via the "Sunshine / shading facade" object. In this case, the new state (beginning of sunshine/shading or end of sunshine/shading) determines the behaviour of the output.

- Set the parameter "Activation of automatic mode by..." on parameter page "Ax - Sun protection" to "Object 'Automatic' & immediate tracking".

Automatic operation is activated as soon as object "Automatic" receives a "1" telegram. The behaviour of the output (beginning of sunshine/shading or end of sunshine/shading) is immediately determined by the state of the object "Sunshine / shading facade".

- i** Depending on the selected setting, the "Automatic" object either has object no. 15 or 16. In case of re-parameterization the assignments of group addresses to the automatic object is lost.

Presetting the polarity of the "Automatic" object (for extended sun protection only)

If the automatic mode is to be activated via the object and only at the next change of state of the sunshine signal (see "Presetting the activation of the automatic mode"), the telegram polarity of the automatic object can be preset in addition.

For the sun protection parameters to be visible, the sun protection function must be enabled on parameter page "Ax – Enabled functions (x = number of output)".

The extended sun protection must be configured for activation of the automatic mode on next change of state.

- Set the parameter "Polarity of 'Automatic' object" on parameter page "Ax - Sun protection" to the required telegram polarity.

The telegram to the "Automatic" object will be evaluated depending on the selected priority.

- i** After an ETS programming operation or after switch-on of the bus and supply voltage, the object "Automatic" must at first have data written into it by the bus also in case of inverted polarity before the automatic operation can be activated.
- i** The polarity of the "Automatic" object is not presettable, if the automatic mode is activated via the object with immediate tracking. In this case, the telegram polarity is fixed: Automatic ON = "1", Automatic OFF = "0".

Presetting the disabling function for the automatic mode (for extended sun protection only)

Automatic mode can be deactivated at any time via a separate disabling object. After enabling of the disabling function in the ETS parameters, the "Automatic mode disable" object becomes visible.

For the sun protection parameters to be visible, the sun protection function must be enabled on parameter page "Ax – Enabled functions (x = number of output)".

The extended sun protection must be configured for activation of the automatic mode with immediate tracking of the sunshine signal.

- Set the parameter "Disabling function for automatic mode ?" on parameter page "Ax - Sun protection" to "yes".

The disabling function is enabled. The parameter for setting of the polarity becomes visible.

- Set the parameter "Polarity of object 'Automatic mode disable'" on parameter page "Ax - Sun protection" to the required telegram polarity.

The telegram to the "Automatic mode disable" object will be evaluated depending on the selected priority.

- i** The objects "Automatic" and "Automatic mode disable" are logically combined (AND with feedback). When disabling is activated, the automatic operation is reset and thus aborted. The output concerned will then show the behaviour at the end of automatic operation. The automatic mode can only be reactivated if the disabling object is released and if object 15 "Automatic" is updated again by writing a "1" into it. Any attempt to activate the automatic mode while a disable is active will be ignored.
- i** After an ETS programming operation or after switch-on of the bus and supply voltage, the objects "Automatic" and "Automatic mode disable" are always initialised with "0". If the disabling object works with inverted polarity (setting "disabled" = "0") the disabling function is in this case immediately active. A bus voltage failure while the external supply voltage is on has no effect on the state of the disabling object.

Presetting the disabling function for direct operation (for extended sun protection only)

The direct mode can be deactivated at any time via a separate disabling object. After enabling of the disabling function in the ETS parameters, the "Direct operation disable" object becomes visible.

For the sun protection parameters to be visible, the sun protection function must be enabled on parameter page "Ax – Enabled functions (x = number of output).

The function must have been configured for extended sun protection.

- Set the parameter "Disabling function for direct mode ?" on parameter page "Ax - Sun protection" to "yes".
The disabling function is enabled. The parameter for setting of the polarity becomes visible.
- Set the parameter "Polarity of object 'Direct operation disable'" on parameter page "Ax - Sun protection" to the required telegram polarity.
The telegram to the "Direction operation disable" object will be evaluated depending on the selected priority.

i After an ETS programming operation or after switch-on of the bus and supply voltage, the "Automatic mode disable" object is always initialised with "0". If the disabling object works with inverted polarity (setting "disabled" = "0") the disabling function is in this case immediately active. A bus voltage failure while the external supply voltage is on has no effect on the state of the disabling object.

Presetting the reaction at the end of automatic operation (for extended sun protection only)

When the automatic operation is being deactivated – also by the disabling function – the output concerned will show the preset reaction, if no function with a higher priority is active at the time of deactivation. The preset reaction will not be executed either on termination of the automatic operation, if the sunshine signal is overridden on account of priority settings by a direct operation. The reaction at the end of automatic operation is preset on parameter page "Ax – Sun protection" (x = number of output). Depending on the selected operating mode, the ETS adapts the designations of the parameter settings ("raising" ↔ "opening the louver" / "lowering" ↔ "closing the louver").

For the sun protection parameters to be visible, the sun protection function must be enabled on parameter page "Ax – Enabled functions (x = number of output).

The function must have been configured for extended sun protection.

- Set the parameter "Reaction at the end of automatic operation" to "no reaction".
At the end of automatic operation the relay of the output shows no reaction. Any movements still in progress at this instant will still be finished.
- Set the parameter "Reaction at the end of automatic operation" to "raising" or "opening the louver".
At the end of automatic operation, the actuator raises the curtain or opens the venting louver.
- Set the parameter "Reaction at the end of automatic operation" to "lowering" or "closing the louver".
At the end of automatic operation, the actuator lowers the curtain or closes the venting louver.
- Set the parameter "Reaction at the end of automatic operation" to "stop".
At the end of automatic operation, the actuator switches the relays of the output to the "stop" position. A drive movement, if any, will be interrupted.
- Set the parameter "Reaction at the end of automatic operation" to "position tracking".

At the end of automatic operation, the output will be set to the state last adjusted statically before the automatic sun protection or to the state tracked and internally stored during the automatic sun protection. The position objects, the long time object and the scene function are tracked.

- i** The behaviour preset in this parameter will only be executed, if no function with a higher priority (e.g. safety) is activated at the end of automatic operation.
- i** Parameter setting "Position tracking": The shutter actuator can track absolute positions (position telegram, scene value) at the end of automatic operation only if the position data are known and if the positions have been predefined. There is otherwise no reaction at the end of automatic operation.
Position data can be tracked, if the output was in a defined position before the automatic sun protection function or if a new position telegram was received via the position objects during the sun protection. In the latter case, a reference movement will be executed at the end of automatic operation, if the position before or during the sun protection was unknown.
Known slat positions will also be tracked as described. This is also the case, when the height of the Venetian blind is unknown.
Long time travel movements (movements without position preset) will always be tracked.

Presetting a time delay for beginning and end of sunshine / shading

The telegram received via the object "Sunshine / shading facade" for activation or deactivation of shading (depending on polarity) can be evaluated with a time delay separately for each output. The preset delay times are always evaluated in the simple as well as in the extended sun protection mode.

For the sun protection parameters to be visible, the sun protection function must be enabled on parameter page "Ax – Enabled functions (x = number of output)".

- Set the parameter "Time delay at the beginning of sunshine / shading" on parameter page "Ax – Beginning of sun protection" to the required delay time.
The telegram for activation of the sun shading will be evaluated with a delay corresponding to the setting.
- Set the parameter "Time delay at the end of sunshine / shading" to the required delay time.
The telegram for deactivation of the sun protection will be evaluated with a delay corresponding to the setting.

- i** A setting of "0" in the parameters deactivates the respective delay time. In this case, the state of the sunshine signal is evaluated immediately.
- i** Simple sun protection mode: An update (from activated to activated) of the "Sunshine / shading facade" object causes the sun protection to be reactivated in consideration of the delay time, if the sun protection had been influenced or aborted beforehand by a direct operation because of the same or a lower priority.
- i** For extended sun protection mode: The time delay is started after an update of the "Sunshine / shading facade" object also in those cases where the automatic operation is deactivated so that the newly received information about the sunshine conditions may possibly also be processed with a delay, if the automatic operation is activated later on. Unlike in the simple sun protection mode, an update of the "Sunshine / shading facade" object from active to active or from inactive to inactive in the extended sun protection mode shows generally no reaction. The behaviour of the output is only influenced if a change of state is being detected. An update of the sunshine signal alone does not result in the activation of the automatic operation either.

Presetting the reaction at the beginning of sunshine / shading

The behaviour of the output at the beginning of sunshine / shading – if applicable, after the end of the delay time – can be configured in the ETS separately for each output. In the simple sun protection mode, the behaviour will be executed, when the sun protection function is activated after receiving a new sunshine signal. In the extended sun protection mode, the output shows the configured reaction, when automatic operation is activated and when a new sunshine signal ("sun is shining") is being received or was received beforehand. The reaction will not be executed if a function with a higher priority is active at the time the sun shading is received.

The reaction at the beginning of sunshine / shading is preset on parameter page "Ax – Beginning of sun protection" (x = number of output). Depending on the selected operating mode, the ETS adapts the designations of the parameter settings ("raising" ↔ "opening the louver" / "lowering" ↔ "closing the louver"). The ETS equally adapts the parameter selection depending on the preset operating mode.

For the sun protection parameters to be visible, the sun protection function must be enabled on parameter page "Ax – Enabled functions (x = number of output)".

- Set the parameter "Reaction at the beginning of sunshine / shading" to "no reaction".
At the beginning of shading, the output switches over to sun protection while the relays of the output show no reaction. Any movements still in progress at this instant will still be finished.
- Set the parameter "Reaction at the beginning of sunshine / shading" to "raising" or "opening the louver".
At the beginning of shading, the actuator raises the curtain or opens the venting louver.
- Set the parameter "Reaction at the beginning of sunshine / shading" to "lowering" or "closing the louver".
At the beginning of shading, the actuator lowers the curtain or closes the venting louver.
- Set the parameter "Reaction at the beginning of sunshine / shading" to "stop".
At the beginning of shading, the actuator switches the relays of the output to the "stop" position. A drive movement, if any, will be interrupted.
- Set the parameter "Reaction at the beginning of sunshine / shading" to "internal scene recall". The number of the scene to be recalled must be specified in the parameter "Scene number (1...8)".
At the beginning of shading, the blinds actuator recalls the position value for the output concerned which was preset in the scene configuration. This is not a scene recall as in direct operation, but only an approach to the corresponding scene position value.
- Set the parameter "Reaction at the beginning of sunshine / shading" to "fixed position".
At the beginning of shading, the blinds actuator recalls a fixed position value for the output concerned.

i In the "Venetian blinds" operating mode, the setting "fixed position" can be selected separately for the height of the Venetian blind and for the slat position. For this reason, the ETS adapts the parameter selection and enlarges the setting options in this operating mode.

- "Fixed position" only: Set the parameter "Fixed position of Venetian blind", "Fixed position of roller shutter/awning" or "Fixed position of venting louver" to "as parameter value". Thereafter, set the parameter "Position of Venetian blind (0...100%)", "Position of roller shutter/awning (0...100%)" or "Position of venting louver (0...100%)" to the desired position.
At the beginning of shading, the output invariably approaches the configured position value.
- "Fixed position" only: Set the parameter "Fixed position of Venetian blind", "Fixed position of roller shutter/awning" or "Fixed position of venting louver" to "no change of current position".
At the beginning of shading, the last set position of the Venetian blind height, the roller shutter, awning or venting louver will be maintained.

- "Fixed position" and operating mode = "Venetian blind" only: Set the parameter "Fixed slat position (0...100%)" to the desired position value.
At the beginning of shading, the output invariably moves the slats to the configured position after the height of the Venetian blind has been adjusted.
- Set the parameter "Reaction at the beginning of sunshine / shading" to "variable position".
At the beginning of shading, the blinds actuator recalls the variably specified position value for the output concerned. The variable specification of the Venetian blind height, the roller shutter, awning or venting louver position takes place via the separate communication object "...pos. sunshine / shading" (in the "Venetian blind" operating mode for the slats also using the separate object "Slat position sunshine / shading").
- ❶ In the "Venetian blind" operating mode, the "variable position" setting can be selected separately for the height of the Venetian blind and for the slat position. For this reason, the ETS adapts the parameter selection and enlarges the setting options in this operating mode.
- ❶ The behaviour preset in this parameter will only be executed, if no function with a higher priority (e.g. safety) is activated at the time of shading.
- ❶ "Internal scene recall" setting: For this setting, the scene function of the output must be enabled in the ETS. Otherwise, the positions approached at the beginning of sun shading are undefined positions. The scene position values stored in the actuator by a scene storage function will be approached as well. A delay configured for scene recalls has no influence on the recall of the scene value by the sun protection function.
- ❶ "Variable position" setting: After an ETS programming operation or after switch-on of the bus and supply voltage, the objects "Sunsh./shading ... position" and "Sunsh./ shading slat position" must receive position values from the bus. Otherwise the actuator does not position itself at the start of sun shading as it does not have any valid position data.
When the actuator is in operation, the position data can be updated at any time via the bus even if the sun protection is active (e.g. by a weather station for the purpose of sun position tracking). The shutter actuator will then immediately approach the newly received positions if the sun protection is active. If a function with a higher priority is active, the actuator stores the newly received position values and approaches them during a later shading operation. The position data last received are not lost in a failure of the bus voltage (external supply voltage is on)

Presetting a forced reference movement in the sun protection mode

If needed, a reference movement can be executed by forced-control in the simple and in the extended sun protection mode at the beginning of a shading cycle, if fixed or variable position values or scene positions are to be approached. The execution of a reference movement by forced control at the beginning of shading can be used in a sun protection positioning operation to ensure that the curtains or slats are moved synchronously by different outputs to identical positions (e.g. in a long row of windows). Without the execution of reference movement by forced control, there might otherwise be positioning inaccuracies with a negative effect on the overall appearance of a building facade with the blinds let down.

A reference movement by forced control will always be executed in the simple sun protection mode, when the beginning of shading is signalled for the first time via the "Sunshine/shading facade" object. Updates of the object from 'sun is shining' to 'sun is shining' do not initiate a reference movement if, at this time, the output is still in the sun protection position.

A reference movement by forced control will be executed in the extended sun protection mode, when the beginning of shading is signalled via the "Sun shading facade" object and when automatic operation is active or is activated. Updates of the object from 'sun is shining' to 'sun is shining' will never initiate a reference movement. In this case, the sunshine signal must first change from 'sun is not shining' to 'sun is shining' before a new reference movement can take place.

A reference movement by forced control will always be executed for synchronisation purposes as described and also in such cases where the position data of the blind or the slats are known. No reference movement by forced control will be executed at the end of shading.

For the sun protection parameters to be visible, the sun protection function must be enabled on parameter page "Ax – Enabled functions (x = number of output).

- Set the parameter "reference movement before every sun protection positioning operation ?" on parameter page "Ax - Beginning of sun protection" (x = number of output) to "yes".
At the beginning of shading there is always a reference movement by forced control as described. The preset position will be approached after the end of the reference movement.
- Set the parameter "reference movement before every sun protection positioning operation ?" on parameter page "Ax - Beginning of sun protection" to "no".
A reference movement at the beginning of sun protection will only be executed if the position data are unknown, for instance, after an ETS programming operation or after switch-on of the bus and supply voltage. In all other cases, the preset shading position will be approached immediately.

- i** A reference movement is the time required for a travel movement into the upper end position increased by 20 % and additionally by the configured travel time extension. A reference travel is not retriggerable.
- i** Variable position preset: No reference movement will be executed, if new position values are preset via the bus while the sun protection is active.
- i** "Venetian Blind" operating mode: A terminated reference movement of for the height of the Venetian blind synchronises at the same time also the slat position.

Slat offset in the sun protection mode (only "Venetian blind" operating mode)

An offset can be specified for the slat position at the start of sun shading separated for each output, if fixed or variable slat position values are to be approached.

If necessary, the slat offset can correct the fixed or variable nominal slat position and thus allow the creation of an individual shading situation, when the sun protection is active. The offset can be preset in two ways...

- The slat offset can be configured statically in the ETS. The configuration of a static offset value allows variation of the degree of shading in those parts of the building that are not exposed to full sunshine due to objects in front of the building. The variable slat angle adjusted by the sun protection control or the fixed angle specified in a parameter can thus be overridden so that the slats are always opened a bit wider than originally preset. Alternatively, the slats can also be closed completely by means of the static offset if too much sunlight is reflected into the room.
- The slat offset can additionally be adapted by the bus via the separate communication object "Sunshine slat position offset". In this way, the desired slat offset can also be adjusted during an active shading cycle and independent of a direct operation as, for instance, the short time mode. Thus, it is possible, for instance, that persons in a room can correct the slat angle at any time 'manually' and individually by selecting another preset value at a touch sensor or a visualisation. An offset preset via the object overwrites the value configured in the ETS.

The preset offset is taken into account in the simple and in the extended sun protection mode for each positioning move during an active shading cycle (beginning of sun / shading) and added to the predefined nominal slat position. The offset value can be varied within a range from -100 % ... 0 ... 100 % so that the slats can be moved in both directions into the respective end positions (Figure 21). At an offset of "0 %", the actual slat position is always identical with the predefined nominal slat position for sun protection purposes.

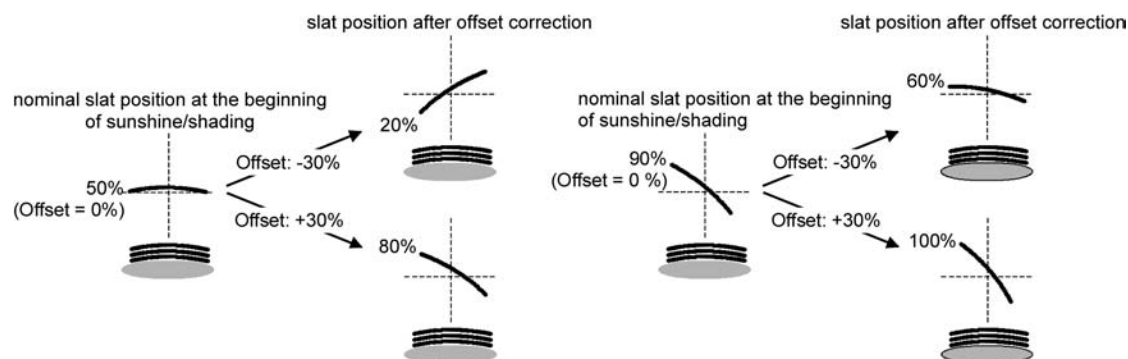

Figure 21: Functional principle of slat offset
(example showing slat type 1 / slat type 2 identical)

The position value actually adjusted with the offset after adding the slat position value is always between 0 and 100 %. Minimum and maximum position are thus determined by the slat end positions. These limits cannot be exceeded by specifying an greater offset. Example ...

Slat position at start of sun / shading = 90 %

Slat position offset at start of sun / shading = +30 %

→ The resulting slat position is 100% as the end position is reached.

In acc. with the KNX datapoint type 6.001 (DPT_Percent_V8), the data format of the communication object "Sunshine slat position offset" permits presetting positive and negative values in a range of -128 ... 0 ... +127. The actuator interprets the value received directly as an offset in %. Values below 100 or above +100 are limited to the minimum (-100 %) and maximum offset (+100 %) and evaluated accordingly.

An offset preset via the object overwrites the value configured in the ETS. In the event of a bus voltage failure or failure of the external supply voltage of the actuator, an offset value received via the communication object can be stored internally in a non-volatile memory so that the offset value last received is not lost. As an alternative, the offset preset via the bus can be reset (0 %) in the event of a power supply failure with the result that the value configured in the ETS is again used in operation. The offset reaction preset in the event of bus or supply voltage failure can be parameterized in the ETS.

Configuring the slat offset in the sun protection mode (only "Venetian blind" operating mode)

For the sun protection parameters to be visible, the sun protection function must be enabled on parameter page "Ax – Enabled functions (x = number of output).

The function must be configured for the "Venetian blind" operating mode.

The reaction at the beginning of sunshine/shading must be configured for fixed or variable position preset.

- Set the parameter "Offset with fixed and variable slat position" on parameter page "Ax - Beginning of sun protection" (x = number of output) to "no offset".

The offset correction is deactivated. During shading (beginning of sunshine/shading), the fixed or variable slat position will be approached without offset correction. The other parameter relating to the offset are blanked out.

- Set the parameter "Offset with fixed and variable slat position" to "offset as configured".

The static offset correction based on the parameter preset in the ETS is activated. During every shading operation (beginning of sunshine/shading), the nominal slat position is always corrected by the configured offset value.

- Set the parameter "Offset with fixed and variable slat position" to "offset as configured and via object".

The offset correction based on the parameter preset in the ETS and via the object is activated. The slat offset is preset by a fixed value configured in the ETS and can be adapted dynamically with a separate communication object. During every shading operation (beginning of sunshine/shading), the nominal slat position is always corrected by the preset offset value.

- Set the parameter "Slat offset position (-100 ... 100 %)" on parameter page "Ax - Beginning of sun protection" to the desired offset value.
The configured value defines the static offset correction of the slat position. The configured value can be re-adjusted via the "Sunshine slat position offset" object, if the communication object has been enabled.
 - Set the parameter "Store offset slat position via object in case of bus/sup.vltg.fail ?" to "No".
The value received via the object will only be stored temporarily in volatile memory. The value received only replaces the configured value until the actuator is reinitialised (bus or supply voltage return, if both were previously switched off). After the initialisation, the offset value configured in the ETS will be used again.
 - Set the parameter "Store offset slat position via object in case of bus/sup.vltg.fail ?" to "Yes".
The value received via the object will be stored in case of bus or supply voltage failure in a non-volatile memory of the actuator. The originally configured offset value is definitely overwritten in the process. Only a new ETS programming operation sets the offset back to the configured value.
- i** An offset value received via the bus is stored temporarily or permanently in the actuator and taken into account during the next shading operation. The reception of an offset value during an active shading phase (beginning of sunshine/shading active) results in an immediate and 'visible' correction of the offset angle by the output.
- i** After an ETS programming operation, the offset is always set to the value configured in the ETS.
- i** Storage of the slat offset position in case of bus/supply voltage failure: The offset value preset via the object is stored only if the bus or supply voltage is still present, or if the bus and supply voltage fail completely after the supply voltage has been available before without interruption for at least 20 seconds after the last reset (storage capacitors sufficiently charged for storage purposes). In all other cases nothing is stored!
- i** The slat offset has no influence on the behaviour of an output at the end of a shading phase (end of sunshine/shading).

Presetting the reaction at the end of sunshine / shading (for simple sun protection only)

At the end of the shading phase – if applicable, after the end of the delay time – the output concerned will show the preset reaction, if no function with a higher priority is active at the time of deactivation. The preset reaction will also not be executed at the end of sun shading, if the sunshine signal is overridden on account of priority settings by a direct operation.

The reaction at the end of sun shading is preset on parameter page "Ax - Sun protection end" (x = number of output). Depending on the selected operating mode, the ETS adapts the designations of the parameter settings ("raising" ↔ "opening the louver" / "lowering" ↔ "closing the louver").

For the sun protection parameters to be visible, the sun protection function must be enabled on parameter page "Ax – Enabled functions (x = number of output).

The function must have been configured for simple sun protection.

- Set the parameter "Reaction at the end of sunshine / shading" to "no reaction".
At the end of shading, the relay of the output shows no reaction. Any movements still in progress at this instant will still be finished.
- Set the parameter "Reaction at the end of sunshine / shading" to "raising" or "opening the louver".
At the end of shading, the actuator raises the curtain or opens the venting louver.
- Set the parameter "Reaction at the end of sunshine / shading" to "lowering" or "closing the louver".
At the end of shading, the actuator lowers the curtain or closes the venting louver.
- Set the parameter "Reaction at the end of sunshine / shading" to "stop".
At the end of shading, the actuator switches the relays of the output to the "stop" position. A drive movement, if any, will be interrupted.
- Set the parameter "Reaction at the end of sunshine / shading" to "position tracking".

At the end of shading, the output will be set to the state last adjusted statically before sun protection or to the state tracked and internally stored during sun protection. The position objects, the long time object and the scene function are tracked.

- i** The behaviour preset in this parameter will only be executed, if no function with a higher priority (e.g. safety) is activated when the sun protection is enabled or when a direct operation has not overridden the sunshine signal on account of priority settings.
- i** Parameter setting "Position tracking": The shutter actuator can track absolute positions (position telegram, scene value) at the end of sun protection only if the position data are known and if the positions have been predefined. There is otherwise no reaction at the end of sun shading.
Position data can be tracked, if the output was in a defined position before the sun protection function or if a new position telegram was received via the position objects during the sun protection. In the latter case, a reference movement will be executed at the end of sun protection, if the position before or during the sun protection was unknown. Known slat positions will also be tracked as described. This is also the case, when the height of the Venetian blind is unknown.
Long time travel movements (movements without position preset) will always be tracked.

Presetting the reaction at the end of sunshine / shading (for extended sun protection only)

The behaviour of the output at the end of sunshine / shading – if applicable, after the end of the delay time – can be configured in the ETS separately for each output. In the enlarged sun protection mode, the output shows the parameterized reaction, when automatic operation is activated and when a new sunshine signal (change of state from "sun is shining" -> "sun is not shining") is being received. The reaction will not be executed if a function with a higher priority is active at the time the sunshine signal changes. The preset reaction will not be executed either, if the sunshine signal is overridden on account of priority settings by a direct operation.

The reaction at the end of sunshine / shading is preset on parameter page "Ax – End of sun protection" (x = number of output). Depending on the selected operating mode, the ETS adapts the designations of the parameter settings ("raising" ↔ "opening the louver" / "lowering" ↔ "closing the louver").

For the sun protection parameters to be visible, the sun protection function must be enabled on parameter page "Ax – Enabled functions (x = number of output)".

The function must have been configured for extended sun protection.

- Set the parameter "Reaction at the end of sunshine / shading" to "no reaction".
At the end of shading, the relay of the output shows no reaction. Any movements still in progress at this instant will still be finished.
- Set the parameter "Reaction at the end of sunshine / shading" to "raising" or "opening the louver".
At the end of shading, the actuator raises the curtain or opens the venting louver.
- Set the parameter "Reaction at the end of sunshine / shading" to "lowering" or "closing the louver".
At the end of shading, the actuator lowers the curtain or closes the venting louver.
- Set the parameter "Reaction at the end of sunshine / shading" to "stop".
At the end of shading, the actuator switches the relays of the output to the "stop" position. A drive movement, if any, will be interrupted.
- Set the parameter "Reaction at the end of sunshine / shading" to "internal scene recall".
The number of the scene to be recalled must be specified in the parameter "Scene number (1...8)".
At the end of shading, the blinds actuator recalls the position value for the output concerned which was preset in the scene configuration. This is not a scene recall as in direct operation, but only an approach to the corresponding scene position value.
- Set the parameter "Reaction at the end of sunshine / shading" to "fixed position".
At the end of shading, the blinds actuator recalls a fixed position value for the output concerned.

i In the "Blind" operating mode, the setting "fixed position" can only be selected in common for the height of the blind and for the slat position.

- "Fixed position" only: Set the parameter "Fixed position of Venetian blind", "Fixed position of roller shutter/awning" or "Fixed position of venting louver" to "as specified by parameter". Thereafter, set the parameter "Position of Venetian blind (0...100%)", "Position of roller shutter/awning (0...100%)" or "Position of venting louver (0...100%)" to the desired position.

At the end of shading, the output invariably approaches the configured position value.

- "Fixed position" only: Set the parameter "Fixed position of Venetian blind", "Fixed position of roller shutter/awning" or "Fixed position of venting louver" to "no change of current position".

At the end of shading, the last set position of the Venetian blind height, the roller shutter, awning or venting louver will be maintained.

- "Fixed position" and operating mode = "Venetian blind" only: Set the parameter "Fixed slat position (0...100%)" to the desired position value.

At the end of shading, the output invariably moves the slats to the configured position after the height of the Venetian blind has been adjusted.

i The behaviour preset in this parameter will only be executed, if no function with a higher priority (e.g. safety) is activated at the time the sunshine signal changes. The preset reaction will not be executed either, if the sunshine signal is overridden on account of priority settings by a direct operation.

i "Internal scene recall" setting: For this setting, the scene function of the output must be enabled in the ETS. Otherwise, the positions approached at the end of sunshine/shading are undefined positions. The scene position values stored in the actuator by a scene storage function will be approached as well. A delay configured for scene recalls has no influence on the recall of the scene value by the sun protection function.

Sun protection application examples

The present chapter describes different applications of the sun protection function of the blinds actuator in combination with the Gira KNX / EIB weather station (order no. 1010 00) and the combination sensor (order no. 1025 00).

The applications described can be used in the simple and in the extended sun protection mode. For the extended sun protection it is important that the automatic function must be activated, if the sunshine signal of the weather station is to be evaluated and an reaction produced at the output. Also, the disabling functions can optionally be used for automatic or direct operation. The following section contains sketches for each application of which communication objects of the weather station should be connected with the blinds actuator.

Information on the appropriate configuration of the KNX / EIB weather station can be find in the appropriate product documentation.

- I. Sun protection with brightness limit value monitoring and fixed sun protection positions:
The limit value monitoring function of the weather station is used. The weather station transmits a "1" telegram via the "Limit value 1 [Sun...]" to the bus when a preset brightness limit value is exceeded. The shutter actuator activates the shading function and adjusts the curtain to the corresponding fixed sun protection position. In the operating mode "Blind" of the shutter actuator, the fixed slat position specified in the parameter is recalled in addition. When the brightness drops below the limit value for the measured brightness (with hysteresis, if programmed), the weather station transmits a "0" telegram to the bus. This deactivates the shading function in the shutter actuator and the corresponding reaction at the end of sunshine /shading will be executed. The communication objects must be linked according to presetting.

Required parameterization of the shutter actuator (parameters not listed are optional):

- simple or enlarged sun protection,
- polarity object "Sunshine / shading facade" = "1" sunshine,
- reaction at the beginning of sunshine / shading = fixed position,
- fixed positions setting.(Figure 22)

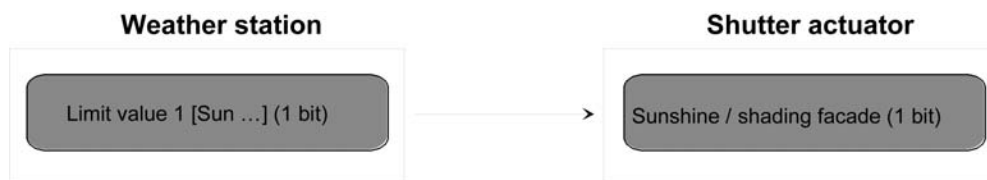

Figure 22: Programming of the communication objects for application example I

- II. Sun protection with shading control and fixed sun protection positions:

The shading control of the weather station is used. When the preset basic brightness for shading operations is exceeded, the weather station transmits a 1-bit telegram of value "1" via the "Shading facade [shading control facades 1-4]" to the bus. The shutter actuator activates the shading function and adjusts the curtain to the corresponding fixed sun protection position. In the operating mode "Blind" of the shutter actuator, the fixed slat position specified in the parameter is recalled in addition.

When the brightness drops below the basic brightness for shading operations (with hysteresis, if programmed), the weather station transmits a "0" telegram to the bus. This deactivates the shading function in the shutter actuator and the corresponding reaction at the end of sunshine /shading will be executed. The communication objects must be linked according to presetting.

Required parameterization of the shutter actuator (parameters not listed are optional):

- simple or enlarged sun protection,
- polarity object "Sunshine / shading facade" = "1" sunshine,
- reaction at the beginning of sunshine / shading = fixed position,
- fixed positions setting.(Figure 23)

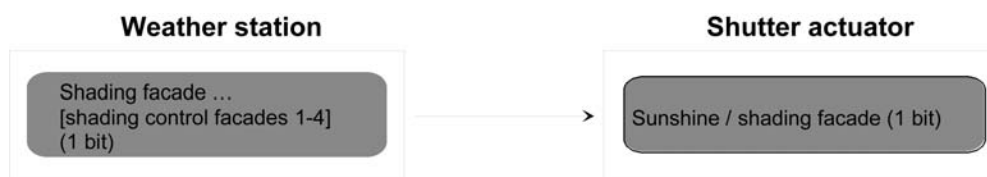

Figure 23: Programming of the communication objects for application example II

- III. Sun protection with shading control and fixed curtain height and variable slat position tracking:

The shading control of the weather station is used. The blinds connected to the shutter actuator are slatted blinds. When the basic brightness for shading operations is exceeded, the weather station transmits a 1-bit telegram of value "1" via the "Shading facade [shading control facade 1-4]" to the bus. The shutter actuator activates the shading function and adjusts the shutter to the corresponding fixed sun protection position. The individual facade control of the weather station transmits additionally the slat position to be preset for sun-dependent slat tracking via the 1-byte object "Slat position (%) facade [individual control facade ...]" to the bus. The slat position required for shading will thus be adjusted in the shutter actuator. When the brightness drops below the basic brightness for shading operations (with hysteresis, if programmed), the weather station transmits a "0" telegram via the "Shading facade [shading control facade 1-4]" to the bus. This deactivates the shading function in the shutter actuator and the corresponding reaction at the end of sunshine / shading will be executed.

Ideally, the telegram "Slat position (%) facade [individual facade control ...]" = "0 %" is suppressed in the weather station by means of a parameter. The extra slat positioning movement might otherwise adversely affect the behaviour of the output at the end of shading (possibly brief bucking).

The global disabling function of the weather station should not be used for disabling the individual facade control. Disabling can be achieved, for instance, with the disabling function of the automatic operation in the shutter actuator and individually for each output. The communication objects must be linked according to presetting.

Required parameterization of the shutter actuator (parameters not listed are optional):

- simple or enlarged sun protection,
- polarity object "Sunshine / shading facade" = "1" sunshine, reaction at the beginning of sunshine / shading = fixed blind position, variable slat position,
- fixed blind position setting.(Figure 24)

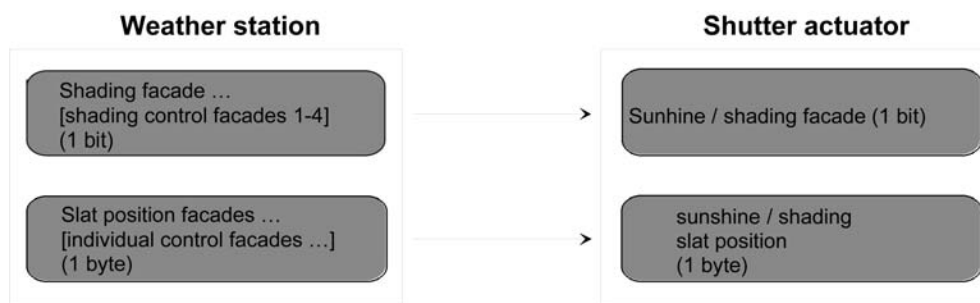

Figure 24: Programming of the communication objects for application example III

- IV. Sun protection with shading control and variable curtain height and variable slat position tracking:

The shading control of the weather station is used. The blinds connected to the shutter actuator are slatted blinds. When the basic brightness for shading operations is exceeded, the weather station transmits a 1-bit telegram of value "1" via the "Shading facade [shading control facade 1-4]" to the bus. The shutter actuator activates the shading function.

The individual facade control of the weather station transmits additionally the slat position to be preset for sun-dependent slat tracking via the 1-byte object "Slat position (%) facade [individual control facade ...]" and the blind height to be adjusted via the 1-byte object "shading facade curtain height threshold/position [individual control facade ...]" to the bus. The slat position and the blind height required for shading will thus be adjusted in the shutter actuator.

When the brightness drops below the basic brightness for shading operations (with hysteresis, if programmed), the weather station transmits a "0" telegram via the "Shading facade [shading control facade 1-4]" to the bus. This deactivates the shading function in the shutter actuator and the corresponding reaction at the end of sunshine / shading will be executed.

Ideally, the telegrams "Slat position (%) facade [individual facade control ...]" = "0 %" and "Shading facade curtain height threshold/position [individual control facade ...]" = 0 % are suppressed in the weather station by means of a parameter. The extra slat and blind positioning movement might otherwise adversely affect the behaviour of the output at the end of shading (possibly brief bucking).

The global disabling function of the weather station should not be used for disabling the individual facade control. Disabling can be achieved, for instance, with the disabling function of the automatic operation in the shutter actuator and individually for each output. The communication objects must be linked according to presetting.

Required parameterization of the shutter actuator (parameters not listed are optional):

- simple or enlarged sun protection,
- polarity object "Sunshine / shading facade" = "1" sunshine,
- reaction at the beginning of sunshine / shading = variable blind position, variable slat position.(Figure 25)

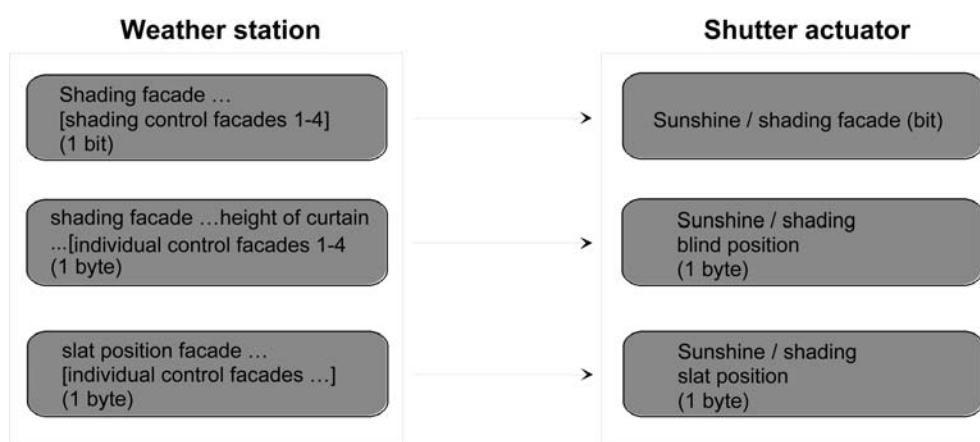

Figure 25: Programming of the communication objects for application example IV

- V. Sun protection with shading control and variable curtain height and fixed slat position:

The shading control of the weather station is used. The blinds connected to the shutter actuator are slatted blinds. When the basic brightness for shading operations is exceeded, the weather station transmits a 1-bit telegram of value "1" via the "Shading facade [shading control facade 1-4]" to the bus. The shutter actuator activates the shading function and adjusts the corresponding fixed sun protection position for the slat angle.

The individual facade control of the weather station transmits additionally the blind height to be adjusted via the

1-byte object "Shading facade curtain height threshold/position [individual control facade ...]" to the bus. The blind height required for shading will thus be adjusted in the shutter actuator.

When the brightness drops below the basic brightness for shading operations (with hysteresis, if programmed), the weather station transmits a "0" telegram via the "Shading facade [shading control facade 1-4]" to the bus. This deactivates the shading function in the shutter actuator and the corresponding reaction at the end of sunshine / shading will be executed.

Ideally, the telegram "Shading facade curtain height threshold/position [individual facade control ...]" = "0 %" is suppressed in the weather station by means of a parameter. The extra blind positioning movement might otherwise adversely affect the behaviour of the output at the end of shading (possibly brief bucking).

The global disabling function of the weather station should not be used for disabling the individual facade control. Disabling can be achieved, for instance, with the disabling function of the automatic operation in the shutter actuator and individually for each output. The communication objects must be linked according to presetting.

Required parameterization of the shutter actuator (parameters not listed are optional):

- simple or enlarged sun protection,
- polarity object "Sunshine / shading facade" = "1" sunshine,
- reaction at the beginning of sunshine / shading = variable blind position, fixed slat position,
- fixed slat position setting.(Figure 26)



Figure 26: Programming of the communication objects for application example V

Automatic heating/cooling

Automatic heating/cooling can supplement the extended sun protection so that the sun shading of a room is available to an additional application.

When automatic heating / cooling is active, a presence signal – e.g. from a KNX / EIB presence monitor or a detector – is evaluated in addition to the signals of the extended sun protection function. The automatic sun protection function will then only be activated by the shutter actuator when persons are in the room. The room is then shaded or not shaded according to the sunshine signal - as described in previous chapters.

If no presence is signalled to the Venetian blind actuator, then the actuator also evaluates a heating/cooling signal, which can be derived from a room temperature controller or an external thermostat, for example. In this case, the shading function can be used to support the heating or

cooling function in a room. As no persons are present in the room, intensive sunlight can be used, for instance, to heat up the room by opening the slats or by raising the curtain. Similarly, the room can also be shaded against sunlight during the absence of persons, if additional heating up of the room is not desired.

The evaluation of the three 1 bit signals "Presence", "Heating/cooling switchover" and "Sunshine / shading facade", whose telegram polarity can be set independently in the ETS, means that the extended sun protection function with automatic heating/cooling differentiates between the 6 statuses shown in Table 2 and the corresponding output reactions.

Presence signal	Heating/cooling switchover	Sunshine / shading facade	Reaction at output
People present	--- (irrelevant)	Sunshine signal active	Reaction at the beginning of sunshine/shading
People present	--- (irrelevant)	Sunshine signal inactive	Reaction at the end of sunshine/shading
No people present	Heating active	Sunshine signal active	Reaction at the beginning of sunshine/shading with heating
No people present	Heating active	Sunshine signal inactive	Reaction at the end of sunshine/shading with heating
No people present	Cooling active	Sunshine signal active	Sunshine signal active reaction at the beginning of sunshine/shading with cooling
No people present	Cooling active	Sunshine signal inactive	Reaction at the end of sunshine/shading with cooling

States of the enlarged sun protection function with heating/cooling switchover

As described for the extended sun protection without automatic heating/cooling, the sunshine signal will be delayed, if a delay is configured in the ETS for this signal. In the same way, the presence signal can be evaluated independently after a delay, for example in order to 'debounce' short time changes to the signal state.

The schematic diagram (Figure 27) shows the interaction of the different communication objects of the extended sun protection function in combination with the automatic heating/cooling function. The diagram moreover illustrates the principle of incorporating sensor components into the automatic heating/cooling system.

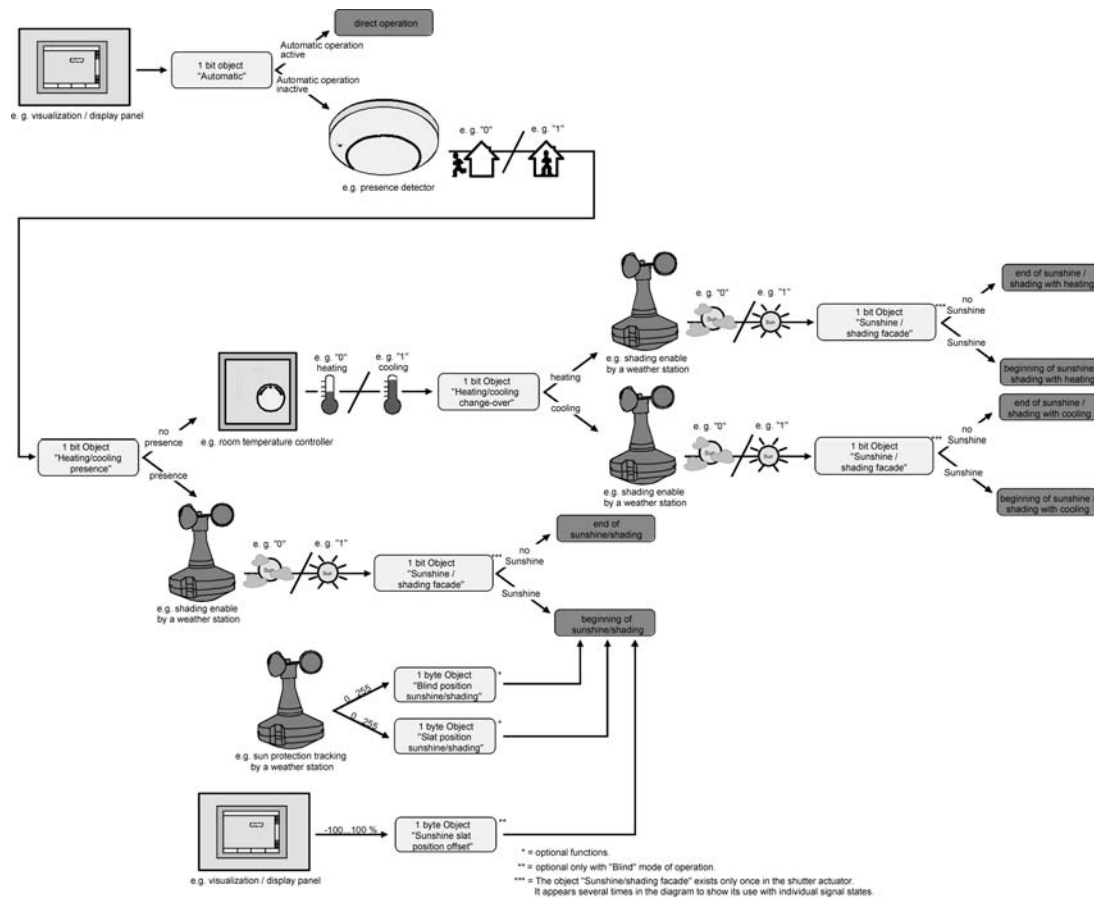

Figure 27: Schematic diagram of automatic heating/cooling (for reasons of simplicity shown without disabling functions of the automatic or direct operation)

In accordance with the schematic diagram, the automatic heating/cooling function is only active when the automatic sun protection is active, too. Like in the extended sun protection mode without automatic heating/cooling, the automatic sun protection is activated via the object "Automatic" depending on the configuration either immediately or only after a change of state has been detected for one of the signals "Presence", "Heating/cooling switchover" and "Sunshine / shading facade" (cf. "Sun protection function – extended sun protection"). After an ETS programming operation or after switch-on of the bus and supply voltage of the actuator, the corresponding communication objects of the signals "Presence", "Heating/cooling switchover" and "Sunshine / shading facade" are initialised with "0". In accordance with the preset polarity, the state of the sunshine and of the presence signal as well as the heating/cooling state will be determined and the corresponding reaction executed provided the automatic sun protection function is active. When the automatic sun protection is active, any change of state of the presence signal or any change in the heating/cooling signal will be evaluated immediately and the corresponding reaction executed.

The schematic function diagram (Figure 28) shows all possible functions of the extended sun protection with automatic heating/cooling. For reasons of clarity, the functions with a higher priority (manual control, forced position, safety function) are not shown in the diagram.

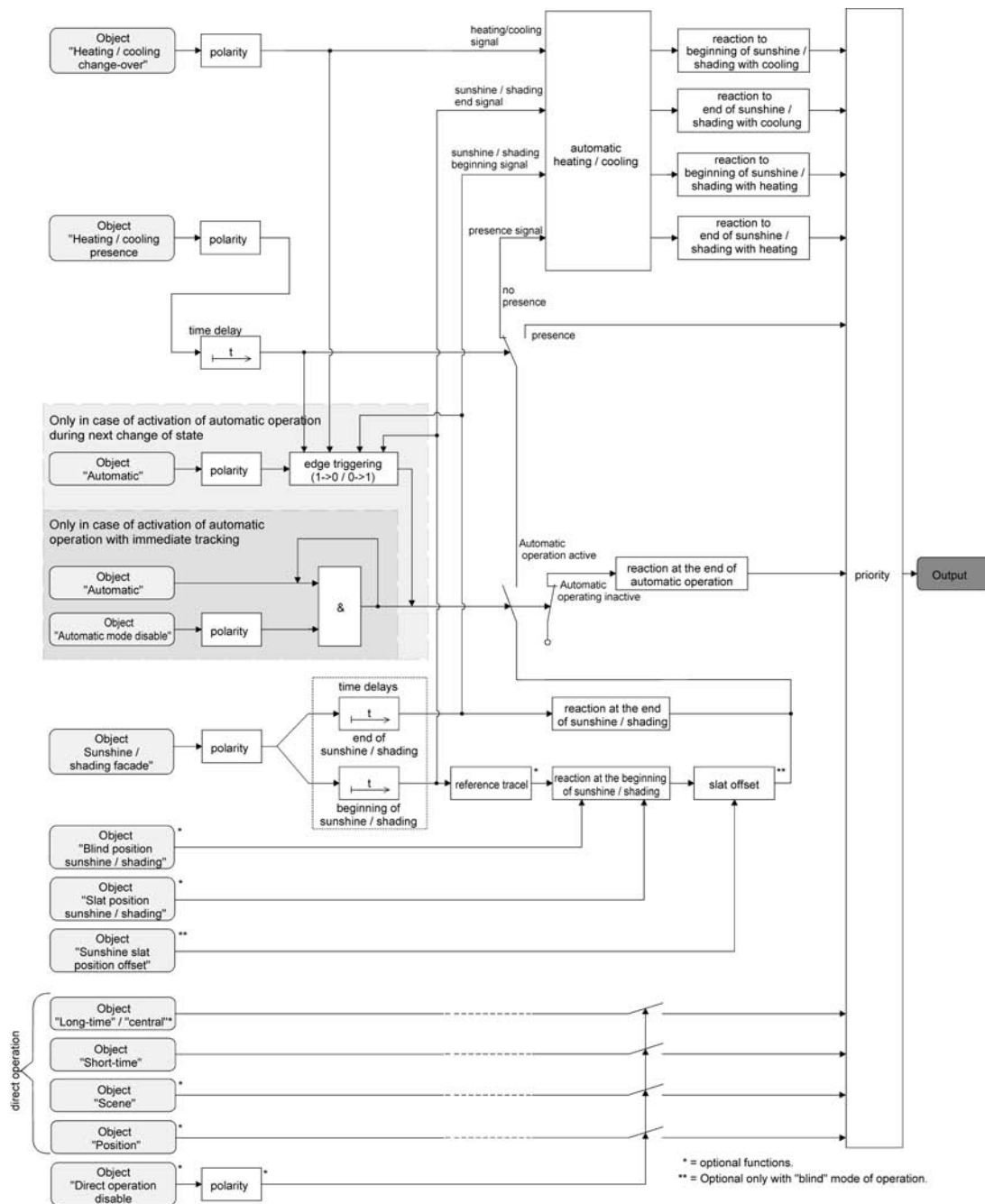

Figure 28: Schematic function diagram of automatic heating/cooling

Enabling automatic heating/cooling

Automatic heating/cooling can be preset separately for each output. When automatic heating/cooling is enabled, the extended sun protection function will be supplemented by the necessary communication objects and parameters.

The sun protection function must be enabled on parameter page

"Ax – Enabled functions (x = number of output). Moreover, the function must have been configured for extended sun protection.

- Set the parameter "Automatic heating/cooling" on parameter page "Ax – Automatic heating/cooling" to "enabled".

The automatic heating/cooling function is enabled. The necessary parameters and communication objects are visible.

- Set the parameter "Automatic heating/cooling" on parameter page "Ax – Automatic heating/cooling" to "disabled".

The automatic heating/cooling function is deactivated. The corresponding parameters and objects are hidden. Only the extended sun protection without evaluation of the heating/cooling and of the presence signal is now configured.

- i** If the automatic heating/cooling activation parameters are changed, the group address assignments and the parameter settings are lost. For this reason, the automatic heating/cooling parameters should be selected directly at the beginning of configuration and then not be changed anymore later on.

Presetting the polarity of the "Heating/cooling switchover" object

The telegram polarity of the "Heating / cooling changeover" object can be preset separately for each output. This means that an adaptation to the signals from existing room temperature controllers or from outside thermostats is possible.

For the parameters to be visible, automatic heating/cooling must be enabled on parameter page "Ax – Automatic heating/cooling" (x = number of output).

- Set the parameter "Polarity of 'Heating/cooling switchover' object" to the required telegram polarity.
The heating/cooling signal is evaluated in accordance with the preset priority.

- i** An update of the "Heating / cooling switchover" object from active to active or from inactive to inactive shows generally no reaction. The behaviour of the output is only influenced if a change of state is being detected.

- i** After switch-on of the bus and supply voltage of the actuator , the heating/cooling switchover function is initialized with an object value of "0".

Presetting the polarity of the "Heating/cooling presence" object

The telegram polarity of the "Heating / cooling presence" object can be preset separately for each output. This means that an adaptation to the signals from existing KNX/EIB presence detectors or motion detectors is possible.

For the parameters to be visible, automatic heating/cooling must be enabled on parameter page "Ax – Automatic heating/cooling" (x = number of output).

- Set the parameter "Polarity of 'Heating / cooling presence' object" to the required telegram polarity.
The presence signal is evaluated in accordance with the preset priority.

- i** An update of the "Heating / cooling presence" object from active to active or from inactive to inactive shows generally no reaction. The behaviour of the output is only influenced if a change of state is being detected.

- i** After switch-on of the bus and supply voltage of the actuator , the heating/cooling presence control is initialized with an object value of "0".

Presetting a time delay for beginning and end of presence

The telegram received via the object "Heating / cooling presence" for transmission of the presence state (depending on polarity) can be evaluated with a time delay separately for each output.

For the parameters to be visible, automatic heating/cooling must be enabled on parameter page "Ax – Automatic heating/cooling" (x = number of output).

- Set the parameter "Time delay at the beginning of presence" to the required delay time.
The telegram for activation of the presence mode will be evaluated with a delay corresponding to the setting.
- Set the parameter "Time delay at the end of presence" to the required delay time.
The telegram for deactivation of the presence mode will be evaluated with a delay corresponding to the setting.

- i** A setting of "0" in the parameters deactivates the respective delay time. In this case, the presence state is evaluated immediately on reception of a telegram.
- i** An update of the "Heating / cooling presence" object from active to active or from inactive to inactive shows generally no reaction. The behaviour of the output is only influenced if a change of state is being detected. An update of the presence signal alone does not result in the activation of automatic operation either.
- i** The time delay is started after an update of the "Heating / cooling presence" object also in those cases where the automatic operation is deactivated so that the newly received presence state may possibly also be processed with a delay, if the automatic operation is activated later on.

Presetting the reaction of automatic heating/cooling

The behaviour of the output when automatic heating/cooling is active can be configured separately for each output. A distinction is made between four states in the evaluation of the three 1-bit signals "Presence", "Heating/cooling switchover" and "Sunshine / shading facade"...

- "Reaction at the **beginning** of sunshine / shading with **heating**",
- "Reaction at the **end** of sunshine / shading with **heating**",
- "Reaction at the **beginning** of sunshine / shading with **cooling**",
- "Reaction at the **end** of sunshine / shading with **cooling**".

The reaction of an output can be set separately in the ETS for each of the named states. There is no difference between the parameter settings for the individual states. For this reason, the following section only describes the possible configuration as an example.

The reaction at the end of automatic heating/cooling is set on parameter page "Ax - Automatic heating/cooling" (x = number of output). Depending on the selected operating mode, the ETS adapts the designations of the parameter settings ("raising" ↔ "opening the louver" / "lowering" ↔ "closing the louver").

For the parameters to be visible, automatic heating/cooling must be enabled on parameter page "Ax – Automatic heating/cooling" (x = number of output).

- Set the parameter "Reaction at the ... of sunshine / shading" to "no reaction".
During automatic heating/cooling, the relays of the output show no reaction. Any movements still in progress will still be finished.
- Set the parameter "Reaction at the ... of sunshine / shading" to "raising" or "opening the louver".
During automatic heating/cooling, the actuator raises the curtain or opens the venting louver.
- Set the parameter "Reaction at the ... of sunshine / shading" to "lowering" or "closing the louver".
During automatic heating/cooling, the actuator lowers the curtain or closes the venting louver.
- Set the parameter "Reaction at the ... of sunshine / shading" to "stop".
During automatic heating/cooling, the actuator switches the relays of the output to the "stop" position. A drive movement, if any, will be interrupted.
- Set the parameter "Reaction at the ... of sunshine / shading" to "internal scene recall". The number of the scene to be recalled must be specified in the parameter "Scene number (1...8)".
During automatic heating/cooling, the shutter actuator recalls the position value preset in the scene configuration for the output concerned. This is not a scene recall as in direct operation, but only an approach to the corresponding scene position value.
- Set the parameter "Reaction at the ... of sunshine / shading" to "fixed position".
During automatic heating/cooling, the blinds actuator recalls the fixed position value for the output concerned.

- i** In the "Venetian blind" operating mode, the setting "fixed position" can only be selected in common for the height of the Venetian blind and for the slat position.

 - "Fixed position" only: Set the parameter "Fixed position of Venetian blind", "Fixed position of roller shutter/awning" or "Fixed position of venting louver" to "as specified by parameter". Thereafter, set the parameter "Position of Venetian blind (0...100%)", "Position of roller shutter/awning (0...100%)" or "Position of venting louver (0...100%)" to the desired position.
During automatic heating/cooling, the output invariably approaches the configured position value.
 - "Fixed position" only: Set the parameter "Fixed position of Venetian blind", "Fixed position of roller shutter/awning" or "Fixed position of venting louver" to "no change of current position".
With automatic heating/cooling, the last set position of the Venetian blind height, the roller shutter, awning or venting louver will be maintained.
 - "Fixed position" and operating mode = "Venetian blind" only: Set the parameter "Fixed slat position (0...100%)" to the desired position value".
During automatic heating/cooling, the output invariably moves the slats to the configured position after the height of the Venetian blind has been adjusted.

- i** The parameterized reactions will not be executed if a function with a higher priority is active during automatic heating/cooling (e.g. safety function, forced position or manual control). The preset reaction will not be executed either, if the automatic sun protection is overridden on account of priority settings by a direct operation.

- i** "Internal scene recall" setting: For this setting, the scene function of the output must be enabled in the ETS. Otherwise, the positions approached during automatic heating/cooling are undefined positions. The scene position values stored in the actuator by a scene storage function will be approached as well. A delay configured for scene recalls has no influence on the recall of the scene value by the automatic heating/cooling function.

Light scene function

An actuator can hold up to 8 scenes for each output and store scene position values for the height of a blind, shutter or awning or the position of a venting louver. In the 'Venetian blinds' mode, the user can also preset slat positions. The scene values are recalled or stored via a separate scene extension object by means of extension telegrams. A scene recall can optionally take place after a delay.

The datapoint type of the extension object permits addressing a maximum of 64 scenes. This means that, in the configuration of a scene, it is possible to specify which scene number (1...64) contacts the internal scene (1...8).

The scene function must be enabled on parameter page "Ax - Enabling functions" (x = number of output) for each output in order for the required communication objects and parameters (on the parameter page "Ax - Scenes") to be visible.

Like the output control via short time, long time, central or position telegrams, the scene function should be assigned to direct operation. For this reason, a recalled scene position can at any time be overridden by a manual control, a forced position or a safety function. The scene position last recalled can also be readjusted by other telegrams of the direct operation mode. The priority of direct operation and also of the scene function can be parameterized with respect to the sun protection function (cf. "Sun protection function").

Presetting a scene recall delay for the scene function

Each scene recall of an output can optionally also be delayed. With this feature, dynamical scene sequences can be configured if several outputs are combined with cyclical scene telegrams.

The scene function must be enabled on parameter page "Ax – Enabled functions (x = number of output).

- Set the parameter "Delay scene recall?" on parameter page "Ax – Scenes" to "yes".

The delay time is now activated and can be configured separately. The delay only influences the scene recall of the output. The delay time is started on arrival of a recall telegram. The corresponding scene will be recalled and the output set to the respective scene position value only after this time has elapsed.

- i** Each scene recall telegram restarts the delay time and retriggers it. If a new scene recall telegram is received while a delay is active (scene recall not yet executed), the old (and not yet recalled scene) will be rejected and only the scene last received executed.
- i** The scene recall delay has no influence on the storage of scene values. A scene storage telegram within a scene recall delay terminates the delay and thus the scene recall.
- i** In case of bus voltage failure, all time functions will be stopped. Therefore, all scene recalls that are still in the delay stage will be aborted. A scene recall received shortly before bus voltage failure is then lost, if the corresponding delay has not yet elapsed. A delayed scene recall will also be aborted, if a function with a higher priority (manual control, forced position, safety, sun protection, if the priority is the same as or higher than that of direct operation) is activated. The scene recall is nevertheless stored internally so that the scene positions last recalled can be tracked at the end of a higher-ranking function.

Presetting the ETS download behaviour for the scene function

During storage of a scene, the scene values are stored permanently in the device (cf. "Presetting the storage behaviour for scene functions"). To prevent the stored values from being replaced during ETS programming of the application or of the parameters by the originally programmed scene position values, the actuator can inhibit overwriting of the scene values. As an alternative, the original values can be reloaded into the device during each programming run of the ETS.

The scene function must be enabled on parameter page "Ax – Enabled functions (x = number of output).

- Set the parameter "Overwrite the values values in the device during ETS download ?" to "Yes".
During each ETS programming of the application or of the parameters, the scene values parameterized in the ETS for the output concerned will be programmed into the actuator. Scene values stored in the device by means of a storage function will be overwritten, if any.
- Set the parameter "Overwrite the values values in the device during ETS download ?" to "No".
Scene values stored in the device with a storage function will be maintained. If no scene values have been stored, the position values last programmed in the ETS remain valid.

- i** When the actuator is put into operation for the first time, this parameter should be set to "yes" so that the output is initialized with valid scene values. In the shutter actuator as delivered, the scene positions are internally set to default values as in the ETS product database.

Presetting scene numbers

The datapoint type of the scene extension object permits addressing of up to 64 scenes max. For this reason, the scene number (1...8) with which the scene is addressed, i.e. recalled or stored, must be determined for each internal scene (1...64) of the output.

The scene function must be enabled on parameter page "Ax – Enabled functions (x = number of output).

- Set the parameter "Scene y activatable by scene number" (y = number of the scene (1...8)) on parameter page "Ax – Scenes" for each scene to the numbers with which the scenes are to be addressed.
A scene can be addressed with the configured scene number. A setting of "0" deactivates the corresponding scene so that neither recalling nor storage is possible.

- i** If the same scene number is configured for several scenes, only the scene with the lowest internal scene number (1...8) will be addressed. The other internal scenes will be ignored in this case.

Presetting scene positions

Moreover, the position value (Venetian blind, roller shutter, awning, venting louver position) to be set for the output in case of a scene recall must be specified as well. In the "Venetian blind" mode, the height of the Venetian blind and the slat position can be preset.

The scene function must be enabled on parameter page

"Ax – Enabled functions (x = number of output).

- Set the parameter "Position ... for scene y" (y = number of the scene (1...8) on parameter page "Ax – Scenes" for each scene to the desired position (0 %...100 %).
In case of a scene recall, the output is set to the configured position.

- i** The parameterized position values are adopted in the actuator during programming with the ETS only if the parameter "Overwrite values stored in the device during ETS download ?" is set to "yes".

- i** Before approaching the required scene position, the shutter actuator performs a reference travel, if the current position data are unknown (e.g. after an ETS programming operation or after switch-on of the bus and supply voltage).

Presetting the storage behaviour for the scene function

The current position value of a Venetian blind, roller shutter, awning, venting louver and also of a slat can be stored internally via the extension object on reception of a scene storage telegram. The position value can be influenced before storage by all functions of the output (e.g. short-time and long-time operation, central or scene recall telegram, safety and sun protection function and manual control).

The scene function must be enabled on parameter page

"Ax – Enabled functions (x = number of output).

- Set the parameter "Storage function for scene y" (y = number of the scene (1...8) on parameter page "Ax – Scenes" for each scene to "yes".

The storage function is activated for the scene in question. On reception of a storage telegram via the "Scene extension" object, the current position value will be internally stored.

- Set the parameter "Storage function for scene y" (y = number of the scene (1...8) on parameter page "Ax – Scenes" for each scene to "no".

The storage function is deactivated for the scene in question. A storage telegram received via the "scene extension" object will be rejected.

- i** The following rules apply for the position data to be stored:
The current blind, slat and louver positions are stored. With Venetian blinds, the height to be stored is always referred to a slat position of 100 %. Positions temporarily approached will be stored also for those outputs that are involved in a travel movement at the time of data storage.
On account of the fact that position data is stored as integer percentage values (rounding to 0...100), a minor deviation from the set positions on a later scene recall cannot be avoided.
The data is only stored if the supply voltage has been available before without interruption for at least 20 seconds after the last reset (storage capacitors sufficiently charged for storage purposes). The data will not be stored, if the position data is unknown.

Forced position function

The forced position function can be enabled for blind output. The forced position has the second highest priority after manual control. It therefore overrides the safety function, the sun protection function and the direct operation (short-time, long-time telegram, scenes, positioning, central). During a forced-position state, the output concerned is locked so that it can no longer be controlled with functions of a lower priority, but only with a manual control. At the end of a manual control, the forced-position action is re-executed if the forced position is still active.

The forced position function has a separate 2-bit communication object for each output. The state of the output in case of a forced position function is directly determined by the forced position telegram. The first bit (bit 0) of the "Forced position" object specifies the travel direction to be forced onto the output as in long time operation. The second bit (bit 1) activates or deactivates the forced-position state(cf. following table).

Bit 1	Bit 0	Function
0	x	Forced position not active normal control
0	x	Forced position not active normal control
1	0	Forced position active, raising / opening the louver
1	1	Forced position active, lowering / closing the louver

Bit coding of forced position

The behaviour of an output at the end of the forced-position function can be configured. In addition, the forced object can be initialised on bus voltage return. An external supply voltage failure alone (bus voltage present) has no effect on the forced position. If only the supply voltage returns, a previously activated forced position remains active.

- i** The forced movement time required by an output to move the drive into the end positions is determined by the "Movement time" parameter on parameter page "Ax - Times". Like long time operation, a forced-position movement is derived from the travel time. Downward travel: travel time + 20 %; Upward travel: travel time + 20 % + parameterized or taught-in travel time extension. Forced movements are not retriggerable.
- i** The slats of blinds are not repositioned at the end of forced movements into the end positions.
- i** Updates of the forced position object from "forced position active" to "forced position active" while maintaining the forced movement direction or from "forced position inactive" to "forced position inactive" show no reaction.
- i** After programming of the application or of the parameters with the ETS, the forced position is always cancelled.
- i** The forced position function remains active even after a bus voltage failure as long as the supply voltage is still on. The forced position function will therefore be executed again at the end of a temporary or permanent manual control – if enabled in case of bus failure – even if there is no bus voltage.
- i** The current state of the forced position function will be stored in case of bus or supply voltage failure.

Enabling the forced position function

The forced position function can be enabled separately for each output.

- Set the parameter "Forced position function" on parameter page "Ax - Enabled functions" (x = number of output) to "enabled".
The forced position function is enabled. The corresponding communication object is created and the respective parameters on parameter page "Ax – Forced position" become visible.

Presetting the behaviour at the end of the forced position function

The behaviour of an output at the end of the forced-position function can be parameterized depending on the channel. The behaviour is parameterized on parameter page "Ax – Forced position" (x = number of output).

The forced position function of an output must be enabled on parameter page "Ax – Enabled functions" (x = number of output). Only then are the channel-related parameters for the forced position function visible.

- Set the parameter "Behaviour at the end of the forced position function" to "position tracking".

At the end of a forced position function, the output will be set to the state adjusted statically before the forced position function or to the state tracked and internally stored during the forced position function. The position objects, the long time object and the scene function are tracked.

- Set the parameter "Behaviour at the end of the forced position function" to "no change".

At the end of forced position function, the state last adjusted will not be changed.

Thereafter, the output is again enabled. Any movements still in progress at this instant will still be finished.

- i** Parameter setting "Position tracking": The shutter actuator can track absolute positions (position telegram, scene value) during activated forced control only if the position data are known and if positions have been predefined. If this is not the case, no reaction takes place at the time forced control is enabled.

Position data can be tracked, if the output has been in a defined position before the forced position function or if a new position telegram has been received via the position objects while the forced position function was interlocked. In the latter case, a reference movement will be executed when the forced position function is enabled, if the position was unknown before or during the safety interlock.

Known slat positions will also be tracked as described. This is also the case, when the height of the Venetian blind is unknown.

Long time movements (movements without position preset) will, however, always be tracked.

- i** The preset "Behaviour at the end of the forced position function" will only be executed, if the output passes over to direct operation at the end of the forced position function. If a safety function or a sun protection function is activated (independent of the preset priority with respect to direct operation), the function with the next lower priority will be executed. The configured behaviour is not executed when the forced position is terminated by a specification on bus voltage return. In this case the parameter "Behaviour after bus/supply voltage return" will be evaluated.

Presetting the behaviour of the forced position function after bus voltage return

The forced position communication object can be initialised after bus voltage return. In this way, an output can be influenced and locked on bus initialisation when the forced position function is being activated.

A supply voltage failure alone has no effect on the forced position. If only the supply voltage returns, a previously activated forced position remains active.

The behaviour of the forced position after bus voltage return is configured separately for each output on the parameter pages "Ax – Forced position" (x = number of output).

Depending on the selected operating mode, the ETS adapts the designations of the parameter settings ("raising" ↔ "opening the louver" / "lowering" ↔ "closing the louver").

After bus voltage return, the configured state is transferred to the "Forced position" communication object.

The forced position function of an output must be enabled on parameter page "Ax – Enabled functions (x = number of output). Only then are the channel-related parameters for the forced position function visible.

- Set the parameter "Behaviour after bus voltage return" to "no forced position active".

The forced position is deactivated after bus voltage return. In this case the parameter "Behaviour after bus/supply voltage return" will be evaluated on bus voltage return.

- Set the parameter "Behaviour after bus voltage return" to "forced position function ON, raising" or "forced position function ON, opening the louver".

After bus voltage return, the forced position is activated and the blind raised or the venting louver opened. The output concerned is interlocked by forced control until an enable signal is received via the bus. The parameter "Behaviour after bus/supply voltage return" will in this case not be evaluated for the output concerned.

- Set the parameter "Behaviour after bus voltage return" to "forced position function ON, lowering" or "forced position function ON, closing the louver".

After bus voltage return, the forced position is activated and the blind lowered or the venting louver closed. The output concerned is interlocked by forced control until an enable signal is received via the bus. The parameter "Behaviour after bus/supply voltage return" will in this case not be evaluated for the output concerned.

- Set the parameter "Behaviour after bus voltage return" to "state of forced position before bus/sup.vltg.fail".

After bus voltage return, the forced-position state last selected and internally stored before bus or supply voltage failure will be tracked. An ETS programming operation deletes the stored state (reaction in that case same as with "no forced position active"). If the tracked state corresponds to "no forced position active", the parameter "Behaviour after bus/supply voltage return" will be executed on return of bus voltage.

- ❗ Setting or tracked state "no forced position active": The reaction of the output concerned after return of bus voltage is defined by the parameter "Behaviour after bus/supply voltage return".
- ❗ After programming of the application or of the parameters with the ETS, the forced position is always cancelled.

'Fabric-stretching' function

In the roller shutter/awning operating mode, the fabric stretching function can be activated. The fabric stretching function permits 'smoothing' the fabric of an awning tight after lowering. The fabric stretching function can also be used with roller shutters to reopen the slits of the shutter curtain after a downward movement into the lower end position.

If activated in the ETS parameters, fabric stretching is executed during each downward movement after stopping and after the configured switchover delay has elapsed. The curtain is then 'stretched' by moving briefly into the opposite movement direction (Figure 29).

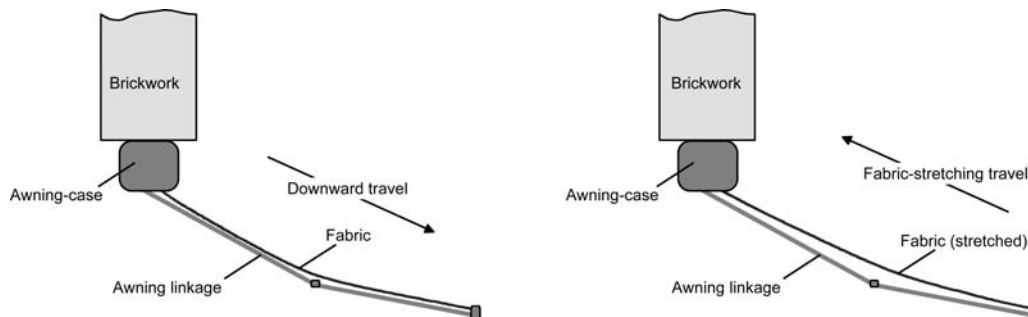

Figure 29: Fabric stretching in an awning

The downward travel can be triggered by any of the following events: Long-time, short-time or position telegram, forced position, safety or sun protection function, central telegram or scene recall and also the manual control.

Fabric stretching is never effected in upward movements.

- ❗ Fabric stretching affects the determination of positions and the position feedback since a fabric stretching movement changes the position of a shutter or an awning. In a positioning move into the lower end position (100 %), the position value reported back after the fabric stretching operation will always be a smaller one.
- ❗ Fabric stretching cannot be configured in the Venetian blind or louver modes of operation.

Activating the fabric stretching function

The fabric-stretching function can be activated independently for each shutter or awning output on parameter page "Ax – Enabled functions" (x = number of output).

The operating mode selected must be the "Roller shutter/awning" mode.

- Set the parameter "Fabric stretching function" to "enabled".
Parameter page "Ax – Fabric-stretching" is enabled and the fabric-stretching function is activated.

i Fabric stretching cannot be configured in the Venetian blind or louver modes of operation.

Presetting the fabric stretching function

The fabric-stretching function can be parameterized independently for each shutter or awning output on parameter page "Ax – Fabric-stretching" (x = number of output). The movement time required for fabric stretching by means of a movement in opposite direction can be configured.

The fabric stretching function must be activated.

- Select the desired value for the "Time for fabric stretching" parameter.
After the end of a downward movement the blind stops and – after the switchover delay has elapsed – moves backwards in opposite direction for a period corresponding to the configured fabric stretching time.

i Set the time for fabric stretching to less than the configured or measured movement time of the roller shutter or awning. Otherwise, there is the risk of malfunction.

i Fabric stretching will only be effected if the downward movement lasts longer than the configured fabric stretching time.

4.2.4.3 Delivery state

In the as-delivered state, the actuator is passive, i.e. no telegrams are transmitted to the bus. The outputs can, however, be operated by manual control on the device, if the external supply voltage is on. In the manual control mode, no feedback telegrams are sent to the bus. Other functions of the actuator are deactivated.

The device can be programmed and put into operation via the ETS. The physical address is preset to 15.15.255.

Moreover the device has been configured at the factory with the following characteristics...

- Movement time (continuous run): 20 minutes
- Movement time extension: 2 %
- Break during movement direction changeover: 1 s
- Behaviour in case of bus voltage failure: no reaction
- Behaviour in case of bus or supply voltage return: stop

4.2.5 Parameters

Description	Values	Comment
<p>☐☐ General</p>		
<p>Delay after bus voltage return Minutes (0...59)</p>	<p>0...59</p>	<p>To reduce telegram traffic on the bus line after bus voltage activation (bus reset), after connection of the device to the bus line or after programming with the ETS, it is possible to delay all active feedback telegrams of the actuator. The parameter specifies in this case a delay valid for all devices. Only after the time configured here has elapsed are feedback telegrams for initialisation transmitted to the bus.</p>
		<p>Setting the delay time minutes.</p>
<p>Seconds (0...59)</p>	<p>0...17...59</p>	<p>Setting the delay time seconds.</p>
<p>Central function ?</p>	<p>Yes No</p>	<p>Setting "yes" enables the central function and thus the "Central travel control" object. Individual blind outputs can be assigned to the central function only if the function is enabled.</p>
<p>Central object polarity</p>	<p>0 = UP; 1 = DOWN 0 = DOWN; 1 = UP</p>	<p>This parameter defines the polarity of the central object.</p>
<p>☐☐ Safety</p>		
<p>Safety functions</p>	<p>disabled enabled</p>	<p>If it is intended to make use of the 5 safety functions of the actuator and to parameterize them, the function must be enabled for all channels (setting "enabled"). If the safety functions are deactivated (setting: "disabled"), any programmed assignment of individual blind outputs to safety monitoring functions is not operational.</p>
<p>Wind alarm 1</p>	<p>disabled enabled</p>	<p>This parameter can be used to enable the first wind alarm and thus to enable the communication object (setting: "enabled"). If the first wind alarm is deactivated (setting: "disabled"), any programmed assignment of individual blind outputs to wind alarm 1 is not operational.</p>
<p>Wind alarm 2</p>	<p>disabled enabled</p>	<p>This parameter can be used to enable the second wind alarm and thus to enable the communication object (setting: "enabled"). If the first wind alarm is deactivated (setting: "disabled"), any programmed assignment of individual blind outputs to wind alarm 2 is not operational.</p>
<p>Wind alarm 3</p>		<p>This parameter can be used to enable the third wind alarm and thus to enable</p>

	disabled enabled	the communication object (setting: "enabled"). If the third wind alarm is deactivated (setting: "disabled"), any programmed assignment of individual blind outputs to wind alarm 3 is not operational.
Rain alarm	disabled enabled	This parameter can be used to enable the rain alarm and thus to enable the communication object (setting: "enabled"). If the rain alarm is deactivated (setting: "disabled"), any programmed assignment of individual blind outputs to the rain alarm is not operational.
Frost alarm	disabled enabled	This parameter can be used to enable the frost alarm and thus to enable the communication object (setting: "enabled"). If the frost alarm is deactivated (setting: "disabled"), any programmed assignment of individual blind outputs to the frost alarm is not operational.
Priority of safety alarms	wind -> rain -> frost wind -> frost -> rain rain -> wind -> frost rain -> frost -> wind frost -> rain -> wind frost -> wind -> rain	This parameter defines the priority ranking of the individual safety alarms. Interpretation: high -> medium -> low. <ul style="list-style-type: none"> i The three wind alarms have the same priority with respect to one another. i The safety alarm enabling parameters and the priority parameter is only visible when the safety functions are enabled.
<input type="checkbox"/> Safety times		
Use wind alarm monitoring function ? (only if wind alarms are enabled!)	Yes No	If the wind alarms enabled under "Safety" are to be monitored cyclically for incoming telegrams to the safety objects, the monitoring function must be enabled here (setting: "yes"). In the opposite case (setting: "no"), the objects are not monitored cyclically. <ul style="list-style-type: none"> i As soon as the monitoring function is activated, telegrams must be transmitted cyclically to all enabled wind alarm objects. i The monitoring function may only be activated, if at least one wind alarm has been activated under "Safety".
Time for monitoring wind alarm Hours (0...23)	0...23	This parameter is used for programming the wind alarm monitoring time. Sets the monitoring time hours.
Minutes (1...59)	1...25...59	Sets the monitoring time minutes. <i>Presetting: 25 minutes</i>

Use rain alarm monitoring function ?	Yes No	<p>i The cycle time of the transmitter should be less than half the parameterized monitoring time of the actuator.</p> <p>i The times can only be set, if wind alarm monitoring is activated.</p> <p>If the rain alarm enabled under "Safety" is to be monitored cyclically for incoming telegrams to the safety object, the monitoring function must be enabled here (setting: "yes"). In the opposite case (setting: "no"), the object is not monitored cyclically.</p> <p>i As soon as the monitoring function is activated, telegrams must be transmitted cyclically to the enabled rain alarm object.</p> <p>i The parameter is only visible, if the rain alarm has been enabled under "Safety".</p>
Time for monitoring rain alarm Hours (0...23)	0...23	<p>This parameter is used for programming the rain alarm monitoring time.</p> <p>Sets the monitoring time hours.</p>
Minutes (1...59)	1... 2 ...59	<p>Sets the monitoring time minutes.</p> <p><i>Presetting: 2 minutes</i></p>
Use frost alarm monitoring function ?	Yes No	<p>i The cycle time of the transmitter should be less than half the parameterized monitoring time of the actuator.</p> <p>i The times can only be set, if rain alarm monitoring is activated.</p> <p>If the frost alarm enabled under "Safety" is to be monitored cyclically for incoming telegrams to the safety object, the monitoring function must be enabled here (setting: "yes"). In the opposite case (setting: "no"), the object is not monitored cyclically.</p> <p>i As soon as the monitoring function is activated, telegrams must be transmitted cyclically to the enabled frost alarm object.</p> <p>i The parameter is only visible, if the frost alarm has been enabled under "Safety".</p>
Time for monitoring frost alarm Hours (0...23)	0...23	<p>This parameter is used for programming the frost alarm monitoring time.</p> <p>Sets the monitoring time hours.</p>
Minutes (1...59)	1... 2 ...59	<p>Sets the monitoring time minutes.</p> <p><i>Presetting: 2 minutes</i></p> <p>i The cycle time of the transmitter should be less than half the parameterized monitoring time of the actuator.</p>

		<p>i The times can only be set, if frost alarm monitoring is activated.</p>
<p>☐ Manual control</p>		
<p>Manual control in case of bus voltage failure</p>	<p>Disabled</p> <p>Enabled</p>	<p>This parameter can be used for programming whether manual control is to be possible (enabled) or deactivated in case of bus voltage failure.</p>
<p>Manual control during bus operation</p>	<p>Disabled</p> <p>Enabled</p>	<p>This parameter can be used for programming whether manual control is to be possible (enabled) or deactivated during bus operation (bus voltage on).</p>
<p>Disabling function ?</p>	<p>Yes</p> <p>No</p>	<p>Manual control can be disabled via the bus, even if it is already active. For this purpose, the disabling object can be enabled here.</p>
<p>Polarity of disable object</p>	<p>0 = enabled; 1 = disabled</p> <p>0 = disabled; 1 = enabled</p>	<p>This parameter sets the polarity of the disabling object.</p> <p>i Only visible if the disabling function for manual control is enabled.</p>
<p>Transmit status ?</p>	<p>Yes</p> <p>No</p>	<p>The current state of manual control can be transmitted to the bus via a separate status object, if bus voltage is available (setting: "Yes").</p>
<p>Status object function and polarity</p>	<p>0 = inactive; 1 = manual control active</p> <p>0 = inactive; 1 = permanent manual control active</p>	<p>This parameter defines the information contained in the status object. The object is always "0", when the manual control mode is deactivated.</p> <p>The object is "1" when the manual control mode is active (temporary or permanent).</p> <p>The object is "1" only when the permanent manual control is active.</p> <p>i This parameter is visible only if the manual control status transmission is enabled.</p> <p>i After bus voltage return, the status will only be transmitted actively to the bus ("0") if a manual control was ended by the bus return.</p>
<p>Behaviour at the end of permanent manual control during bus operation</p>	<p>No change</p>	<p>The behaviour of the actuator at the end of permanent manual control depends on this parameter.</p> <p>All telegrams received during an active permanent manual control mode for direct operation (long-time/short-time, positioning, scenes) are be rejected. After the end of the permanent manual control mode, the current state of all outputs remains unchanged. If, however, a function with a higher priority is being activated during manual control (safety, forced position, sun protection), the actuator activates the higher-ranking function for the corresponding outputs.</p>

	output tracking	During an active permanent manual control all incoming telegrams (short-time telegrams excepted) are internally tracked. At the end of manual control, the outputs are adjusted accordingly.
Disable bus control of individual outputs during bus operation	Yes	Individual outputs can be disabled locally during permanent manual control, so that the disabled outputs can no longer be controlled via the bus. Disabling via manual control is only permitted if this parameter is set to "Yes".
	No	
<p>☐ Ax - General (x = number of output / All outputs can be parameterized independent of one another.)</p>		
Mode of operation (to be adjusted first!)	blind	The blind actuator can be used to control different drive systems. This parameter defines which type of drive or which type of curtain is connected to the output.
	shutter / awning	
	venting louver	
Behaviour after ETS programming		<p>i The ETS adapts all of the following parameters (designations, visible/non visible, etc.) dynamically to the respective "mode of operation" parameter. For this reason, the "Mode of operation" parameter should be adjusted before all other parameters of an output.</p>
		The actuator permits setting the preferred relay contact position after ETS programming separately for each output.
	Raising / opening the louvre	After programming with the ETS, the actuator raises the blind or opens the venting louvre.
	Lowering / closing the louvre	After programming with the ETS, the actuator lowers the blind or closes the venting louvre.
	Stop	After programming with the ETS, the actuator switches the relays of the output to the "stop" position. A drive movement, if any, will be interrupted.
		<p>i The configured behaviour will be executed after every application or parameter download by the ETS. A simple download of the physical address alone or partial programming of only the group addresses has the effect that this parameter is disregarded and that the parameterized "Behaviour after bus/supply voltage return" will be executed instead.</p>
Behaviour in case of bus voltage failure		The actuator permits setting the preferred relay contact position in case of bus voltage failure separately for each output.
	Stop	

		In case of bus voltage failure, the actuator switches the relays of the output to the "stop" position. A drive movement, if any, will be interrupted.
	Raising / opening the louvre	After bus voltage failure, the actuator raises the blind or opens the venting louvre.
	Lowering / closing the louvre	After bus voltage failure, the actuator lowers the blind or closes the venting louvre.
	Approaching a position	In case of bus voltage failure, the connected drive can approach a position specified by further parameters.
	No reaction	In the event of bus voltage failure, the relay of the output shows no reaction. Any drive movements still in progress at the time of failure will be completely finished.
		<ul style="list-style-type: none"> i The configured behaviour will only be executed, if no manual control is activated.
Position of Venetian blind in case of bus voltage failure (0...100%)	0...100	<p>This parameter specifies the Venetian blind position to be approached in case of bus voltage failure.</p> <ul style="list-style-type: none"> i This parameter is only visible, if "Behaviour in case of bus voltage failure" is set to "approach position". i This parameter is only visible in the Venetian blind operating mode.
Position of slat in case of bus voltage failure (0...100%)	0...100	<p>This parameter specifies the slat position to be approached in case of bus voltage failure after the Venetian blind has been positioned at the desired height.</p> <ul style="list-style-type: none"> i This parameter is only visible, if "Behaviour in case of bus voltage failure" is set to "approach position". i This parameter is only visible in the Venetian blind operating mode.
Position of roller shutter/awning in case of bus voltage failure (0...100%)	0...100	<p>This parameter specifies the roller shutter or awning position to be approached in case of bus voltage failure.</p> <ul style="list-style-type: none"> i This parameter is only visible, if "Behaviour in case of bus voltage failure" is set to "approach position". i This parameter is only visible in the roller shutter/awning operating mode.
Position of venting louvre in case of bus voltage failure (0...100%)	0...100	This parameter specifies the venting louvre position to be approached in case of bus voltage failure.

Behaviour after bus or supply voltage return

- i** This parameter is only visible, if "Behaviour in case of bus voltage failure" is set to "approach position".
- i** This parameter is visible only in the 'Venting louvre' operating mode.

The actuator permits setting the preferred relay contact position after bus or supply voltage return separately for each output. This means that the configured behaviour is executed when either the bus voltage or the supply voltage is switched on again.

Stop

In case of bus or supply voltage return, the actuator switches the relays of the output to the "stop" position. A drive movement, if any, will be interrupted.

Raising / opening the louvre

After bus or supply voltage return, the actuator raises the curtain or opens the venting louvre.

Lowering / closing the louvre

After bus or supply voltage return, the actuator lowers the curtain or closes the venting louvre.

Position during bus/sup. vltg. failure

After bus or supply voltage return, the forced-position state last selected and internally stored before bus or supply voltage failure will be tracked.

Approaching a position

In case of bus or supply voltage return, the connected drive can approach a position specified by further parameters.

No reaction

In the event of bus or supply voltage return, the relay of the output shows no reaction. Any drive movements still in progress at the time of failure will be completely finished.

The reactions active at the time of supply voltage failure are re-executed on return of the supply voltage. Interrupted short or long time travel movements are restarted at full length and position approaches are continued from the point of interruption.

- i** The configured behaviour will only be executed, if no forced position on bus voltage return is activated.

Venetian blind position on bus/sup. vltg. return (0...100%) **0...100**

This parameter specifies the Venetian blind position to be approached in case of bus or supply voltage return.

- i** This parameter is only visible if "behaviour after a bus or supply voltage return" is set to "approach position".

- i** This parameter is only visible in the Venetian blind operating mode.

Slat position on bus/ sup. vltg. return (0...100%) **0...100**

This parameter specifies the slat position to be approached in case of bus or supply voltage return after the

<p>Roller shutter/awning position on bus/sup. vltg. return (0...100%)</p>	<p>0...100</p>	<p>Venetian blind has been positioned at the desired height.</p> <p>i This parameter is only visible if "behaviour after a bus or supply voltage return" is set to "approach position".</p> <p>i This parameter is only visible in the Venetian blind operating mode.</p> <p>This parameter specifies the roller shutter/awning position to be approached in case of bus or supply voltage return.</p> <p>i This parameter is only visible if "behaviour after a bus or supply voltage return" is set to "approach position".</p> <p>i This parameter is only visible in the roller shutter/awning operating mode.</p>
<p>Position of venting louver on return of bus/sup. vltg. return (0...100%)</p>	<p>0...100</p>	<p>This parameter specifies the venting louver position to be approached in case of bus or supply voltage return.</p> <p>i This parameter is only visible if "behaviour after a bus or supply voltage return" is set to "approach position".</p> <p>i This parameter is visible only in the 'Venting louvre' operating mode.</p>
<p>Travelling time extension for upward travel</p>	<p>2 % 3 % 4 % 5 % 6 % 7 % 8 % 9 % 10 % 12.5 %</p>	<p>The blind actuator prolongs all upward movements or venting louver movements into the open position based on the time extension specified in this parameter. The time extension expressed in percent is the difference between the measured travel time needed to reach the lower end position (completely closed position) and the time needed to reach the upper end position (completely open position).</p> <p>i This parameter is only visible, when the automatic end position detection is not deactivated.</p>
<p><input type="checkbox"/> Ax - Times (x = number of output / All outputs can be parameterized independent of one another.)</p>		
<p>Short time operation</p>	<p>No (only stop)</p> <p>Yes</p>	<p>This parameter can be used to configure the reaction to a received short time telegram.</p> <p>The drive will only be stopped if it is executing a movement at the time of telegram reception. There is no reaction if no movement is in progress.</p> <p>Short-time operation is started on reception of a short-time telegram when the drive is stationary. If the drive is in motion at the time of telegram reception, it will be stopped.</p>

Time for short time operation Seconds (0...59)	0... 2 ...59	<p>This parameter defines the duration of short-time operation.</p> <p>Sets the monitoring time seconds.</p>
Milliseconds (0...99 x 10)	0...99	<p>Sets the monitoring time milliseconds.</p> <p><i>Presetting: 2 seconds</i></p> <ul style="list-style-type: none"> i The duration of short time operation should in no case exceed half the slat adjusting time. i This parameter is only visible, if the parameter "Short time operation" is set to "yes".
Blind travelling time Minutes (0...19)	0... 1 ...19	<p>This parameter defines the travelling time of the blind. The time needed for a complete travel from the upper into the lower end position must be determined.</p> <p>Sets the minutes of the blind travelling time.</p>
Seconds (0...59)	0... 40 ...59	<p>Sets the seconds of the blind travelling time.</p> <p><i>Presetting: 40 seconds</i></p> <ul style="list-style-type: none"> i The travelling time must be determined precisely. i The travelling time parameters are only visible when the automatic end position detection is not enabled. i These parameters are visible only in the 'Blind' mode of operation.
Shutter/awning travelling time Minutes (0...19)	0... 1 ...19	<p>This parameter defines the travelling time of the shutter or awning. The time needed for a complete travel from the upper into the lower end position must be determined.</p> <p>Sets the minutes of the shutter or awning travelling time.</p>
Seconds (0...59)	0... 40 ...59	<p>Sets the seconds of the shutter or awning travelling time.</p> <p><i>Presetting: 40 seconds</i></p> <ul style="list-style-type: none"> i The travelling time must be determined precisely. i The travelling time parameters are only visible when the automatic end position detection is not enabled. i These parameters are visible only in the 'Shutter/awning' mode of operation.
Venting louver travelling time Minutes (0...19)	0... 1 ...19	<p>This parameter defines the travelling time of the venting louver. The time needed for a complete travel from the completely open into the completely closed position must be determined.</p>

Seconds (0...59)	0... 40 ...59	<p>Sets the minutes of the venting louver travelling time.</p> <p>Sets the seconds of the venting louver travelling time.</p> <p><i>Presetting: 40 seconds</i></p> <ul style="list-style-type: none"> i The travelling time must be determined precisely. i The travelling time parameters are only visible when the automatic end position detection is not enabled. i These parameters are visible only in the 'Venting louver' mode of operation.
Slat moving time Minutes (0...19)	0...19	<p>This parameter defines the travelling time of the slats. The time needed for a complete travel movement from the completely open slat position into the completely closed slat position (downward direction) must be determined.</p> <p>Sets the minutes of the slat moving time.</p>
Seconds (0...59)	0... 5 ...59	<p>Sets the seconds of the slat moving time.</p> <p><i>Presetting: 5 seconds</i></p> <ul style="list-style-type: none"> i The travelling time must be determined precisely. i The slat moving time must be selected shorter than the blind travelling time. i These parameters are visible only in the 'Blind' mode of operation.
Change-over time for travel direction changes	0.5 s 1 s 2 s 5 s	<p>Defines the break during a change of travel direction (change-over time).</p>
<p><input type="checkbox"/> Ax - Enabled functions (x = number of output / All outputs can be parameterized independent of one another.)</p>		
Feedback functions	disabled enabled	<p>This parameter can be used to disable or to enable the feedback functions. When the function is enabled, the required parameters will be displayed under "Ax –Feedbacks".</p>
Safety functions	disabled enabled	<p>This parameter can be used disable or to enable the safety functions. When the function is enabled, the required parameters will be displayed under "Ax –Safety".</p>
Sun protection functions	disabled enabled	<p>This parameter can be used disable or to enable the sun protection functions. When the function is enabled, the corresponding parameters will be displayed under "Ax - Sun protection" (3 parameter nodes) and the necessary objects enabled.</p>

Scene function	disabled enabled	This parameter can be used disable or to enable the scene function. When the function is enabled, the corresponding parameters will be displayed under "Ax - Scenes" and the necessary object enabled.
Forced position function	disabled enabled	This parameter can be used to disable or to enable the forced position function. When the function is enabled, the corresponding parameters will be displayed under "Ax - Forced position" and the necessary object enabled.
Fabric-stretching function	disabled enabled	This parameter can be used disable or to enable the fabric-stretching function. When the function is enabled, the corresponding parameters will be displayed under "Ax - Fabric-stretching" and the necessary object enabled. i This parameter is visible only in the 'Shutter/awning' mode of operation.
Assignment to central function ?	yes (enable central function under "General") No	This parameter determines the assignment of the output to the central function. The output is assigned to the central function. The central function is supposed to have been enabled under "General". The assignment has otherwise no effect on the blind output. The output is not assigned to the central function.
<input type="checkbox"/> Ax - Feedback telegrams (x = number of output)		
Venetian blind position feedback	No feedback Feedback object is active signalling object Feedback object is passive status object	The current Venetian blind position of the output can be reported separately back to the bus. No feedback object available for the output. Feedback deactivated. Feedback and the object are activated. The object transmits actively (telegram transmission after change). Feedback and the object are activated. The object is passive (telegram transmission only as a response to 'Read' request). i The communication flags of the object are automatically set by the ETS according to the setting. i This parameter is only visible in the Venetian blind operating mode.
Roller shutter/awning position feedback	No feedback	The current roller shutter or awning position of the output can be reported separately back to the bus. No feedback object available for the output. Feedback deactivated.

	Feedback object is active signalling object	Feedback and the object are activated. The object transmits actively (telegram transmission after change).
	Feedback object is passive status object	Feedback and the object are activated. The object is passive (telegram transmission only as a response to 'Read' request). <ul style="list-style-type: none"> i The communication flags of the object are automatically set by the ETS according to the setting. i This parameter is only visible in the roller shutter/awning operating mode.
Venting louvre position feedback	No feedback	The current venting louvre position of the output can be reported separately back to the bus. No feedback object available for the output. Feedback deactivated.
	Feedback object is active signalling object	Feedback and the object are activated. The object transmits actively (telegram transmission after change).
	Feedback object is passive status object	Feedback and the object are activated. The object is passive (telegram transmission only as a response to 'Read' request). <ul style="list-style-type: none"> i The communication flags of the object are automatically set by the ETS according to the setting. i This parameter is visible only in the 'Venting louvre' operating mode.
Time delay for feedback telegram after bus voltage return ?	Yes (delay time under "General") No	The feedback telegram can be transmitted to the bus with a delay after bus voltage return or after programming with the ETS. Setting "Yes" activates the delay time of the feedback in case of bus voltage return. The delay time is configured under "General". <ul style="list-style-type: none"> i This parameter is only visible in case of an actively transmitting feedback object.
Slat position feedback	No feedback	The current slat position of the output can be reported separately back to the bus. No feedback object available for the output. Feedback deactivated.
	Feedback object is active signalling object	Feedback and the object are activated. The object transmits actively (telegram transmission after change).
	Feedback object is passive status object	Feedback and the object are activated. The object is passive (telegram transmission only as a response to 'Read' request). <ul style="list-style-type: none"> i The communication flags of the object are automatically set by the ETS according to the setting.

Time delay for feedback telegram after bus voltage return ?	Yes (delay time under "General") No	<p>i This parameter is only visible in the Venetian blind operating mode.</p> <p>The feedback telegram can be transmitted to the bus with a delay after bus voltage return or after programming with the ETS. Setting "Yes" activates the delay time of the feedback in case of bus voltage return. The delay time is configured under "General".</p>
Invalid Venetian blind position feedback	No feedback	<p>i This parameter is only visible in case of an actively transmitting feedback object.</p> <p>The actuator can report to the bus that the current blind position is unknown (e.g. after an initialisation, when no reference travel has been executed as yet).</p>
	Feedback object is active signalling object	<p>No feedback object available for the output. Feedback deactivated.</p> <p>Feedback and the object are activated. The object transmits actively (telegram transmission after change).</p>
	Feedback object is passive status object	<p>Feedback and the object are activated. The object is passive (telegram transmission only as a response to 'Read' request).</p>
Invalid roller shutter/awning position feedback	No feedback	<p>i The communication flags of the object are automatically set by the ETS according to the setting.</p> <p>i This parameter is only visible in the Venetian blind operating mode.</p> <p>The actuator can report to the bus that the current roller shutter/awning position is unknown (e.g. after an initialisation, when no reference travel has been executed as yet).</p>
	Feedback object is active signalling object	<p>No feedback object available for the output. Feedback deactivated.</p> <p>Feedback and the object are activated. The object transmits actively (telegram transmission after change).</p>
	Feedback object is passive status object	<p>Feedback and the object are activated. The object is passive (telegram transmission only as a response to 'Read' request).</p>
Invalid venting louvre position feedback		<p>i The communication flags of the object are automatically set by the ETS according to the setting.</p> <p>i This parameter is only visible in the roller shutter/awning operating mode.</p> <p>The actuator can report to the bus that the current venting louvre position is unknown (e.g. after an initialisation, when no reference travel has been executed as yet).</p>

	No feedback	No feedback object available for the output. Feedback deactivated.
	Feedback object is active signalling object	Feedback and the object are activated. The object transmits actively (telegram transmission after change).
	Feedback object is passive status object	Feedback and the object are activated. The object is passive (telegram transmission only as a response to 'Read' request). <i>i</i> The communication flags of the object are automatically set by the ETS according to the setting. <i>i</i> This parameter is visible only in the 'Venting louvre' operating mode.
Time delay for feedback telegram after bus voltage return ?	Yes (delay time under "General") No	The feedback telegram can be transmitted to the bus with a delay after bus voltage return or after programming with the ETS. Setting "Yes" activates the delay time of the feedback in case of bus voltage return. The delay time is configured under "General". <i>i</i> This parameter is only visible in case of an actively transmitting feedback object.
Drive movement feedback		The actuator can report to the bus that the connected drive is active, i.e. the output is supplying power to the drive for a travel direction.
	No feedback	No feedback object available for the output. Feedback deactivated.
	Feedback object is active signalling object	Feedback and the object are activated. The object transmits actively (telegram transmission after change).
	Feedback object is passive status object	Feedback and the object are activated. The object is passive (telegram transmission only as a response to 'Read' request). <i>i</i> The communication flags of the object are automatically set by the ETS according to the setting.
Time delay for feedback telegram after bus voltage return ?	Yes (delay time under "General") No	The feedback telegram can be transmitted to the bus with a delay after bus voltage return or after programming with the ETS. Setting "Yes" activates the delay time of the feedback in case of bus voltage return. The delay time is configured under "General". <i>i</i> This parameter is only visible in case of an actively transmitting feedback object.
<input type="checkbox"/> Ax - Safety (x = number of output)		
Assignment to wind alarms	No Wind alarm 1	This parameter defines whether the output responds to a wind alarm and to which of the alarms.

	Wind alarm 2	
	Wind alarm 3	
	Wind alarm 1 + 2	
	Wind alarm 1 + 3	
	Wind alarm 2 + 3	
	Wind alarm 1 + 2 + 3	
Behaviour in case of wind alarm		This parameter defines the behaviour of the output at the beginning of a wind alarm.
	no reaction	At the beginning of the wind alarm or wind alarms, the output is interlocked and the relay of the output shows no reaction. Any travel movements in progress at this instant will still be completely finished.
	raising / opening the louver	The actuator raises the curtain or opens the venting louver at the beginning of the wind alarm or wind alarms and locks the output thereafter.
	raising / closing the louver	The actuator lowers the curtain or closes the venting louver at the beginning of the wind alarm or wind alarms and locks the output thereafter.
	stop	At the beginning of the wind alarm or wind alarms, the actuator switches the relays of the output to "stop" and locks the output. A travel movement, if any, will be interrupted.
		<p>i The behaviour preset in this parameter will be executed when one of the assigned wind alarms is activated.</p> <p>i This parameter is only visible, if the output has been assigned to at least one wind alarm.</p>
Assignment to rain alarm	Yes	This parameter defines whether the output responds to the rain alarm.
	No	
Behaviour in case of rain alarm		This parameter defines the behaviour of the output at the beginning of the rain alarm.
	no reaction	At the beginning of the rain alarm, the output is interlocked and the relay of the output shows no reaction. Any travel movements in progress at this instant will still be completely finished.
	raising / opening the louver	The actuator raises the curtain or opens the venting louver at the beginning of the rain alarm and locks the output thereafter.
	raising / closing the louver	

		The actuator lowers the curtain or closes the venting louver at the beginning of the rain alarm and locks the output thereafter.
	stop	At the beginning of the rain alarm, the actuator switches the relays of the output to "stop" and locks the output. A travel movement, if any, will be interrupted. i This parameter is only visible, if the output has been assigned to the rain alarm.
Assignment to frost alarm	Yes	This parameter defines whether the output responds to the frost alarm.
	No	
Behaviour in case of frost alarm		This parameter defines the behaviour of the output at the beginning of the frost alarm.
	no reaction	At the beginning of the frost alarm, the output is interlocked and the relay of the output shows no reaction. Any travel movements in progress at this instant will still be completely finished.
	raising / opening the louver	The actuator raises the curtain or opens the venting louver at the beginning of the frost alarm and locks the output thereafter.
	raising / closing the louver	The actuator lowers the curtain or closes the venting louver at the beginning of the frost alarm and locks the output thereafter.
	stop	At the beginning of the frost alarm, the actuator switches the relays of the output to "stop" and locks the output. A travel movement, if any, will be interrupted. i This parameter is only visible, if the output has been assigned to the frost alarm.
Behaviour at the end of safety (wind, rain, frost)		This parameter defines the behaviour of the output at the end of all safety functions.
	no reaction	At the end of the safety functions, the output is unlocked and the relay of the output shows no reaction. Any travel movements still in progress at this instant will still be finished.
	raising / opening the louver	The actuator unlocks the output at the end of all safety alarms and raises the curtain or opens the venting louver.
	raising / closing the louver	The actuator unlocks the output at the end of the safety functions and lowers the curtain or closes the venting louver.
	stop	At the end of the safety functions, the output is unlocked and the actuator

	<p>switches the relays of the output into the "stop" position. A travel movement, if any, will be interrupted.</p>
<p>tracking the position</p>	<p>At the end of safety, the output will be set to the state last adjusted before the safety function or to the state tracked and internally stored during the safety function. The position objects, the long-time object and the scene function are tracked.</p> <p>i The behaviour preset in this parameter will only be executed, if the output passes over to direct operation at the end of safety. Direct operation will be executed when a sun protection function is active.</p>
<p>☐ Ax – Sun protection (x = number of output)</p>	
<p>Type of sun protection</p>	<p>This parameter defines the scope of sun protection functions.</p>
<p>simple sun protection</p>	<p>Reduced scope of functions with standard configuration possibilities.</p>
<p>enlarged sun protection mode</p>	<p>Enlarged scope of functions including the possibilities of the simple sun protection. In addition, the connected drive can be integrated in shading control systems depending on the position of the sun. Automatic heating/cooling can also be realized.</p>
<p>Priority of sun protection with respect to direct operation</p>	<p>This parameter defines the priority of the sun protection function with respect to direct operation.</p>
<p>same priority</p>	<p>The sun protection can be overridden by direct operation and vice versa. Only after the next reception of a "sun is shining" signal will the sun protection mode be activated again.</p>
<p>higher priority</p>	<p>The sun protection has the higher priority and cannot be aborted by a direct operation.</p>
<p>Lower priority</p>	<p>The direct operation has the higher priority and cannot be aborted by sun protection. The sun protection can be activated only after an enabling movement into the upper end position initiated by a direct operation has occurred without interruption.</p>
	<p>i Direct operation = long-time/short-time operation; Positioning via objects, scenes, central control.</p>
	<p>i This parameter is only visible in the simple sun protection.</p>
	<p>This parameter defines the priority of automatic operation with respect to</p>

Priority of automatic operation with respect to direct operation	<p>same priority</p> <p>higher priority</p> <p>Lower priority</p>	<p>direct operation. The selected priority affects the evaluation of the sunshine signal in the automatic mode and not the automatic mode itself.</p> <p>The evaluation of the sunshine signal in the automatic mode can be overridden by a direct operation. In the same way, a direct operation is overridden by the reception of a new sunshine telegram.</p> <p>The automatic mode has the higher priority and cannot be aborted by a direct operation irrespective of the state of the sunshine signal. A direct operation will be possible again only after the automatic mode is terminated.</p> <p>The direct operation has the higher priority and cannot be aborted by a sunshine signal in the automatic mode. The sunshine signal is evaluated again only after an enabling movement into the upper end position initiated by a direct operation has occurred without interruption and only if the automatic mode is activated and not disabled at this time.</p>
Polarity of the "Sunshine / shading facade" object	<p>sunshine = 1; no sunshine = 0</p> <p>Sunshine = 0; no sunshine = 1</p>	<p>i Direct operation = long-time/short-time operation; Positioning via objects, scenes, central control.</p> <p>i This parameter is only visible in the extended sun protection.</p> <p>This parameter defines the polarity of the input object "Sunshine / shading facade" of the sun protection.</p>
Activation of automatic operation via...	<p>Object "Automatic" & next change of state</p> <p>object "Automatic" & immediate tracking</p>	<p>This parameter defines how to activate the automatic mode and the reactions resulting from such activation.</p> <p>Automatic operation is activated as soon as the "Automatic" object is set to 'active' in consideration of polarity. A reaction at the output occurs, however, only after a new change of state has been signalled via the "Sunshine / shading facade" object. In this case, the new state (beginning of sun protection or end of sun protection) determines the behaviour of the output.</p> <p>Automatic operation is activated as soon as the "Automatic" object receives a "1" telegram. The state of the object "Sunshine / shading facade" immediately determines the behaviour of the output (beginning of sun protection, end of sun protection).</p>

Polarity of "Automatic" object	Automatic mode: activated = 1; deactivated = 0	<p>i The reception of a telegram 'Automatic mode inactive' at the "Automatic" object immediately ends the automatic mode in both cases. The behaviour is in this case defined by the parameter "Reaction at the end of automatic operation".</p> <p>This parameter defines the polarity of the automatic object.</p>
	Automatic mode: activated = 0; deactivated = 1	<p>i This parameter is only visible, if the parameter "Activation of automatic operation via..." is set to "automatic" & next change of state".</p>
Disabling function for automatic mode ?	Yes No	<p>The automatic mode can be disabled. When disabling is active, the automatic mode is aborted. It can only be reactivated, if a "1" is written into the "Automatic" object. The objects "Automatic" and "Automatic mode disable" are logically combined (AND with feedback). The "Yes" setting enables the disabling function and makes the disabling object visible.</p>
Polarity of "Automatic mode disable" object	Automatic mode: enabled = 1; disabled = 0 Automatic mode: enabled = 0; disabled = 1	<p>i This parameter is only visible, if the parameter "Activation of automatic operation via..." is set to "object automatic & immediate tracking".</p> <p>This parameter defines the polarity of the automatic mode disable object. Disabling is active when a telegram with polarity 'disabled' is received.</p> <p>i This parameter is only visible, if the parameter "Disabling function for automatic mode ?" is set to "Yes".</p>
Disabling function for direct operation ?	Yes No	<p>Direct operation can be disabled. When disabling is active, a direct operation can – independently of the preset priority – never abort a sun protection function. In this case, direct operation is disabled in other functions, too. The "Yes" setting enables the disabling function and makes the disabling object visible.</p>
		<p>i Direct operation = long-time/short-time operation; Positioning via objects, scenes, central control.</p>
Polarity of "Direct operation disable" object	Automatic mode: enabled = 1; disabled = 0 Automatic mode: enabled = 0; disabled = 1	<p>This parameter defines the polarity of the disabling object for direct operation. Disabling is active when a telegram with polarity 'disabled' is received.</p> <p>i This parameter is only visible, if the parameter "Direct operation disable?" is set to "Yes".</p>
Reaction at the end of automatic operation		<p>This parameter defines the behaviour of the output at the end of automatic operation and also at the beginning of an automatic operation disable.</p>

no reaction	At the end of automatic operation, the sun protection function is ended and the relay of the output shows no reaction. Any travel movements still in progress at this instant will still be finished.
raising / opening the louver	At the end of automatic operation, the actuator terminates the sun protection and raises the curtain or opens the venting louver.
raising / closing the louver	At the end of automatic operation, the actuator terminates the sun protection and lowers the curtain or closes the venting louver.
stop	At the end of automatic operation the sun protection is terminated and the actuator switches the relays of the output to "stop". A travel movement, if any, will be interrupted.
tracking the position	<p>At the end of automatic operation, the output will be set to the state last adjusted before the automatic sun protection or to the state tracked and internally stored during the automatic sun protection. The position objects, the long-time object and the scene function are tracked.</p> <p>i The behaviour preset in this parameter will only be executed, if no function with a higher priority (e.g. safety) is activated at the end of automatic operation.</p>
<p>☐ Ax - Beginning of sun protection (x = number of output)</p>	
<p>Time delay beginning of sunshine / shading Minutes (0...59)</p>	<p>0...59</p> <p>The telegram received via the object "Sunshine / shading facade " for activation of shading (according to polarity) can be evaluated with a time delay.</p>
<p>Seconds (0...59)</p>	<p>0...30...59</p> <p>Setting the minutes of the delay time.</p> <p>Setting the delay time seconds.</p> <p><i>Presetting: 30 seconds</i></p> <p>i A time setting of "0" in the parameters deactivates the respective delay time. In this case, the state of shading is evaluated immediately.</p>
<p>Reaction at the beginning of sunshine / shading</p>	<p>This parameter defines the behaviour of the output at the beginning of shading – if applicable, after the end of the delay time.</p>
<p>No reaction</p>	<p>At the beginning of shading, the output switches over to sun protection while the relays of the output show no reaction. Any movements still in progress at this instant will still be finished.</p>
<p>Raising</p>	<p></p>

		At the beginning of shading, the actuator raises the blind.
	Lowering	At the beginning of shading, the actuator lowers the blind.
	Stop	At the beginning of shading, the actuator switches the relays of the output to the "stop" position. A drive movement, if any, will be interrupted.
	Internal scene recall	At the beginning of sun shading, the Venetian blind actuator recalls the position values set in the scene configuration for the appropriate output. This is not a scene recall as in direct operation, but only an approach of the corresponding scene position values.
	Venetian blind or slat position fixed	At the beginning of shading, the output controls the approach to a configured fixed Venetian blind and slat position.
	Venetian blind position fixed / slat position variable	At the beginning of shading, the output controls the approach to a configured fixed Venetian blind position and to slat position preset by a separate object and thus variable.
	Slat position fixed / Venetian blind position variable	At the beginning of shading, the output controls the approach to a configured fixed slat position and to a Venetian blind position preset by a separate object and thus variable.
	Venetian blind and slat position variable	At the beginning of shading, the output controls the approach to the Venetian blind and slat positions preset by two separate objects and thus variable.
		i This parameter is visible only in the "Venetian blind" operating mode.
Reaction at the beginning of sunshine / shading		This parameter defines the behaviour of the output at the beginning of shading – if applicable, after the end of the delay time.
	No reaction	At the beginning of shading, the output switches over to sun protection while the relays of the output show no reaction. Any movements still in progress at this instant will still be finished.
	Raising	At the beginning of shading, the actuator raises the blind.
	Lowering	At the beginning of shading, the actuator lowers the blind.
	Stop	At the beginning of shading, the actuator switches the relays of the output to the "stop" position. A drive movement, if any, will be interrupted.
	Internal scene recall	At the beginning of sun shading, the Venetian blind actuator recalls the position values set in the scene configuration for the appropriate output.

		<p>This is not a scene recall as in direct operation, but only an approach of the corresponding scene position values.</p>
	<p>Fixed roller shutter / awning position</p>	<p>At the beginning of shading, the output controls the approach to a configured fixed roller shutter / awning position.</p>
	<p>Roller shutter / awning position variable</p>	<p>At the beginning of shading, the output controls the approach to the roller shutter / awning position preset by a separate object and thus variable.</p> <p>i This parameter is visible only in the "Roller Shutter / Awning" operating mode.</p>
<p>Reaction at the beginning of sunshine / shading</p>		<p>This parameter defines the behaviour of the output at the beginning of shading – if applicable, after the end of the delay time.</p>
	<p>No reaction</p>	<p>At the beginning of shading, the output switches over to sun protection while the relays of the output show no reaction. Any movements still in progress at this instant will still be finished.</p>
	<p>Opening the louvre</p>	<p>At the beginning of shading, the actuator opens the venting louvre.</p>
	<p>Closing the louvre</p>	<p>At the beginning of shading, the actuator closes the venting louvre.</p>
	<p>Stop</p>	<p>At the beginning of shading, the actuator switches the relays of the output to the "stop" position. A drive movement, if any, will be interrupted.</p>
	<p>Internal scene recall</p>	<p>At the beginning of sun shading, the Venetian blind actuator recalls the position values set in the scene configuration for the appropriate output. This is not a scene recall as in direct operation, but only an approach of the corresponding scene position values.</p>
	<p>Fixed venting louvre position</p>	<p>At the beginning of shading, the output controls the approach to a configured fixed venting louvre position.</p>
	<p>Venting louvre position variable</p>	<p>At the beginning of shading, the output controls the approach to the venting louvre position preset by a separate object and thus variable.</p> <p>i This parameter is visible only in the "Venting louvre" operating mode.</p>
<p>Scene number (1...8)</p>	<p>1...8</p>	<p>This parameter defines the number of the internal scene which is recalled at the beginning of shading.</p> <p>i This parameter is only visible, if the parameter "Reaction at the beginning of sunshine / shading" is set to "internal scene recall".</p>
<p>Fixed Venetian blind position</p>		<p>The fixed Venetian blind position at the beginning of shading can either be</p>

		<p>preset statically by a separate parameter or basically adjusted to the value prevailing at the time of shading activation, i.e. remain unchanged.</p>
	<p>Same as configured value</p>	<p>At the beginning of shading, the configured Venetian blind position value will be approached.</p>
	<p>No change in current position</p>	<p>At the beginning of shading, the current position of the Venetian blind will be maintained. In this case, the output behaves as if only the slat were positioned as a result of shading.</p>
		<p>i This parameter is only visible, if the Venetian blind is to approach a fixed position at the beginning of shading.</p>
		<p>i This parameter is visible only in the 'Venetian blind' operating mode.</p>
<p>Venetian blind position (0...100 %)</p>	<p>0...50...100</p>	<p>This parameter sets the fixed position of the Venetian blind to be approached at the beginning of shading.</p>
		<p>i This parameter is only visible, if the parameter "Fixed position of Venetian blind" is set to "as specified by parameter".</p>
		<p>i This parameter is visible only in the 'Venetian blind' operating mode.</p>
<p>Fixed slat position (0...100 %)</p>	<p>0...50...100</p>	<p>This parameter sets the fixed position of the slat to be approached at the beginning of shading and, as the case may be, after positioning of the Venetian blind.</p>
		<p>i This parameter is only visible, if the slat is to approach a fixed position at the beginning of shading.</p>
		<p>i This parameter is visible only in the 'Venetian blind' operating mode.</p>
<p>Fixed roller shutter / awning position</p>		<p>The fixed position of the roller shutter or awning at the beginning of shading can either be preset statically by a separate parameter or basically adjusted to the value prevailing at the time of shading activation, i.e. remain unchanged.</p>
	<p>Same as configured value</p>	<p>At the beginning of shading, the configured roller shutter or awning position will be approached.</p>
	<p>No change in current position</p>	<p>At the beginning of shading, the current position of the roller shutter or awning will be maintained. Any movements in progress at the time of shading activation will be finished.</p>
		<p>i This parameter is only visible when the roller shutter or awning should approach a fixed position value at the beginning of sun shading.</p>

Position of roller shutter / awning (0...100 %)	0... 50 ...100	<p>i This parameter is visible only in the "Roller Shutter / Awning" operating mode.</p>
Fixed position of venting louvre	Same as configured value	<p>This parameter sets the fixed position of the roller shutter or awning to be approached at the beginning of shading.</p> <p>i This parameter is only visible, if the parameter "Fixed position of shutter / awning" is set to "as specified by parameter".</p> <p>i This parameter is only visible in the "Roller shutter/Awning" operating mode.</p> <p>The fixed venting louvre position at the beginning of shading can either be preset statically by a separate parameter or basically adjusted to the value prevailing at the time of shading activation, i.e. remain unchanged.</p>
Position of venting louvre (0...100 %)	0... 50 ...100	<p>At the beginning of shading, the configured venting louvre position will be approached.</p> <p>No change in current position</p> <p>At the beginning of shading, the current position of the venting louvre will be maintained. Any movements in progress at the time of shading activation will be finished.</p> <p>i This parameter is only visible if the venting louvre is to approach a fixed position at the beginning of shading.</p> <p>i This parameter is visible only in the "Venting louvre" mode of operation.</p> <p>This parameter sets the fixed position of the venting louvre to be approached at the beginning of shading.</p> <p>i This parameter is only visible, if the parameter "Fixed position of venting louvre" is set to "as specified by parameter".</p> <p>i This parameter is visible only in the "Venting louvre" operating mode.</p>
Reference movement before each sun protection positioning operation ?	Yes No	<p>A forced reference movement of the drive is performed before sun protection positioning (setting "yes"). A reference movement is a positioning movement into the upper end position or into the completely open position. By means of a forced reference movement, drives connected to different outputs can be synchronised. If no synchronising movement is forced (setting "no"), the actuator performs a reference movement only once after return of the power supply.</p>
Offset with fixed and variable slat position		<p>For 'manual' readjustment of the slat angle during a shading or sun position tracking operation, a slat offset can be</p>

		<p>preset. The offset corrects the preset slat angle in positive or in negative direction. The lighting conditions in a room can thus be individually adapted by persons present in the room.</p>
	no offset	The offset correction is deactivated.
	Offset as configured	The slat offset is statically preset by means of a fixed parameter value.
	Offset as configured and via object	The slat offset is preset by a fixed parameter value and can be dynamically adapted via a separate communication object.
		<ul style="list-style-type: none"> i This parameter is only visible, if the slat is to approach a fixed or a variable position at the beginning of shading. i This parameter is visible only in the 'Venetian blind' operating mode.
Offset slat position (-100..100 %)	-100... 0 ...100	<p>This parameter is used for setting the slat offset. The value specified in this parameter is added at the beginning of shading to the current slat angle.</p> <ul style="list-style-type: none"> i Even with offset correction, the 0...100% slat position limits cannot be overstepped. i It should be noted that the configured offset value can be overwritten by the object after reception of a dynamic value. i This parameter is only visible, if the parameter "Offset with fixed and variable slat position" is set to "Offset as configured" or to "Offset as configured and via object". i This parameter is visible only in the 'Venetian blind' operating mode.
Store offset slat position via object in case of bus/sup.vltg.fail ?"		If the offset is preset via the object, this parameter defines whether the received value is to be stored in the actuator's NV memory.
	yes	The value received via the object will be stored in case of bus or supply voltage failure in a non-volatile memory of the actuator. The originally configured offset value is definitely overwritten in the process.
	No	The value received via the object will only be stored temporarily in volatile memory. It only replaces the configured value until the actuator is reinitialised (bus or supply voltage return, if both were previously switched off). After the initialisation, the offset value configured in the ETS will be used again.

		<ul style="list-style-type: none"> i This parameter is only visible, if the parameter "Offset with fixed and variable slat position" is set to "offset as configured and via object". i This parameter is visible only in the 'Venetian blind' operating mode.
☐↵ Ax - End of sun protection (x = number of output)		
Time delay end of sunshine / shading Minutes (0...59)	0...59	The telegram received via the object "Sunshine / shading facade " for deactivation of shading (according to polarity) can be evaluated with a time delay.
		Setting the minutes of the delay time.
Seconds (0...59)	0... 30 ...59	Setting the delay time seconds.
		<i>Presetting: 30 seconds</i>
		<ul style="list-style-type: none"> i A time setting of "0" in the parameters deactivates the respective delay time. In this case, the state of shading is evaluated immediately.
Reaction at the end of sunshine / shading		This parameter defines the behaviour of the output at the end of shading – if applicable, after the end of the delay time.
	no reaction	At the end of shading, the output quits the sun protection mode and the relays of the output show no reaction. Any travel movements still in progress at this instant will still be finished.
	raising / opening the louver	At the end of shading, the actuator raises the curtain or opens the venting louver.
	lowering / closing the louver	At the end of shading, the actuator lowers the curtain or closes the venting louver.
	stop	At the end of shading, the actuator switches the relays of the output to the "stop" position. A travel movement, if any, will be interrupted.
		<ul style="list-style-type: none"> i The behaviour preset in this parameter will only be executed if no function with a higher priority (e.g. safety) is activated at the end of shading. i This parameter is only visible in the simple sun protection.
	tracking the position	At the end of shading, the output will be set to the state last adjusted before sun protection or to the state tracked and internally stored during sun protection. The position objects, the long-time object and the scene function are tracked.

Reaction at the end of
sunshine / shading

no reaction	This parameter defines the behaviour of the output at the end of shading – if applicable, after the end of the delay time.
raising	At the end of shading, the relays of the output show no reaction. Any travel movements still in progress at this instant will still be finished.
lowering	At the end of shading, the actuator raises the curtain.
stop	At the end of shading, the actuator lowers the curtain.
internal scene recall	At the end of shading, the actuator switches the relays of the output to the "stop" position. A travel movement, if any, will be interrupted.
blind or slat position fixed	At the end of shading, an internal scene of the actuator is recalled.
	At the end of shading, the output moves to a parameterized fixed blind and slat position.

i This parameter is only visible in the enlarged sun protection.

i This parameter is visible only in the 'Blind' mode of operation.

i This parameter does not define the behaviour of the output at the end of automatic operation (cf. parameter "Reaction at the end of automatic operation")!

Reaction at the end of
sunshine / shading

no reaction	This parameter defines the behaviour of the output at the end of shading – if applicable, after the end of the delay time.
raising	At the end of shading, the relays of the output show no reaction. Any travel movements still in progress at this instant will still be finished.
lowering	At the end of shading, the actuator raises the curtain.
stop	At the end of shading, the actuator lowers the curtain.
internal scene recall	At the end of shading, the actuator switches the relays of the output to the "stop" position. A travel movement, if any, will be interrupted.
shutter / awning position fixed	At the end of shading, an internal scene of the actuator is recalled.
	At the end of shading, the output moves to a parameterized fixed shutter / awning position.

i This parameter is only visible in the enlarged sun protection.

Reaction at the end of
sunshine / shading

no reaction

opening the louver

closing the louver

stop

internal scene recall

**venting louver position
fixed**

Scene number (1...8)

1...8

Fixed position of blind

as specified by parameter

no change in current
position

i This parameter is visible only in the "Shutter / awning" mode of operation.

i This parameter does not define the behaviour of the output at the end of automatic operation (cf. parameter "Reaction at the end of automatic operation")!

This parameter defines the behaviour of the output at the end of shading – if applicable, after the end of the delay time.

At the end of shading, the relays of the output show no reaction. Any travel movements still in progress at this instant will still be finished.

At the end of shading, the actuator opens the venting louver.

At the end of shading, the actuator closes the venting louver.

At the end of shading, the actuator switches the relays of the output to the "stop" position. A travel movement, if any, will be interrupted.

At the end of shading, an internal scene of the actuator is recalled.

At the end of shading, the output moves to a parameterized fixed venting louver position.

i This parameter is only visible in the enlarged sun protection.

i This parameter is visible only in the "Venting louver" mode of operation.

i This parameter does not define the behaviour of the output at the end of automatic operation (cf. parameter "Reaction at the end of automatic operation")!

This parameter defines the number of the internal scene which is recalled at the end of shading.

i This parameter is only visible, if the parameter "Reaction at the end of sunshine / shading" is set to "internal scene recall".

The fixed blind position at the end of shading can either be preset statically by a separate parameter or basically remain at the value set or tracked by the shading operation.

At the end of shading, the parameterized blind position will be approached.

At the end of shading, the current position of the blind will be maintained.

Position of blind (0...100 %)	0... 50 ...100	<p>In this case, the output behaves as if only the slat were positioned as a result of the end of shading.</p> <ul style="list-style-type: none"> <li data-bbox="976 351 1500 436">i This parameter is only visible, if the blind is to approach a fixed position at the end of shading. <li data-bbox="976 450 1500 507">i This parameter is visible only in the 'Blind' mode of operation. <p>This parameter sets the fixed position of the blind to be approached at the end of shading.</p> <ul style="list-style-type: none"> <li data-bbox="976 626 1500 743">i This parameter is only visible, if the parameter "Fixed position of blind" is set to "as specified by parameter". <li data-bbox="976 755 1500 812">i This parameter is visible only in the 'Blind' mode of operation.
Fixed position of slat (0...100 %)	0... 50 ...100	<p>This parameter sets the fixed position of the slat to be approached at the end of shading and, as the case may be, after positioning of the blind.</p> <ul style="list-style-type: none"> <li data-bbox="976 966 1500 1051">i This parameter is only visible, if the slat is to approach a fixed position at the beginning of shading. <li data-bbox="976 1063 1500 1120">i This parameter is visible only in the 'Blind' mode of operation.
Fixed position of shutter / awning	<p>as specified by parameter</p> <p>no change in current position</p>	<p>The fixed position of the shutter or awning at the end of shading can either be preset statically by a separate parameter or basically adjusted to the value prevailing at the time of shading activation, i.e. remain unchanged.</p> <p>At the end of shading, the parameterized shutter / awning position will be approached.</p> <p>At the end of shading, the current position of the shutter or awning will be maintained. Any travel movements in progress at the time of shading activation will be finished.</p> <ul style="list-style-type: none"> <li data-bbox="976 1609 1500 1694">i This parameter is only visible, if the shutter or awning is to approach a fixed position at the end of shading. <li data-bbox="976 1705 1500 1786">i This parameter is visible only in the "Shutter / awning" mode of operation.
Position of shutter / awning (0...100 %)	0... 50 ...100	<p>This parameter sets the fixed position of the shutter or awning to be approached at the end of shading.</p> <ul style="list-style-type: none"> <li data-bbox="976 1912 1500 2029">i This parameter is only visible, if the parameter "Fixed position of shutter / awning" is set to "as specified by parameter". <li data-bbox="976 2041 1500 2126">i This parameter is visible only in the "Shutter / awning" mode of operation.

Fixed position of venting louver

The fixed venting louver position at the end of shading can either be preset statically by a separate parameter or basically adjusted to the value prevailing at the time of shading activation, i.e. remain unchanged.

as specified by parameter

At the end of shading, the parameterized venting louver position will be approached.

no change in current position

At the end of shading, the current position of the venting louver will be maintained. Any travel movements in progress at the time of shading activation will be finished.

i This parameter is only visible if the venting louver is to approach a fixed position at the end of shading.

i This parameter is visible only in the "Venting louver" mode of operation.

Position of venting louver (0...100 %)

0...**50**...100

This parameter sets the fixed position of the venting louver to be approached at the end of shading.

i This parameter is only visible, if the parameter "Fixed position of venting louver" is set to "as specified by parameter".

i This parameter is visible only in the "Venting louver" mode of operation.

Ax – Automatic heating/cooling (x = number of output)

Automatic heating/cooling

disabled

enabled

This parameter can be used to activate the automatic heating/cooling function. The automatic heating/cooling function adds a presence detection function to the enlarged sun protection mode. If a person is present, the enlarged sun protection is executed as described. If nobody is present, however, the blinds, shutters, awnings or venting louvers can be operated in such a way that these devices support the heating or cooling function of the building.

When the function is enabled, the other parameters and objects are visible.

i The automatic heating/cooling function can only be activated in the enlarged sun protection mode.

i Moreover, the automatic heating/cooling function is only active when the automatic mode of the enlarged sun protection function is activated.

Object polarity "Heating/cooling switchover"

Cooling = 0;
Heating = 1

Cooling = 1;
Heating = 0

This parameter defines the polarity of the object for heating/cooling switchover.

This object is linked, for instance, with room temperature controllers or outside thermometers.

Object polarity "Heating/cooling presence"	No presence = 0; Presence = 1	<ul style="list-style-type: none"> i The heating/cooling switchover is initialised after the return of the supply voltage of the actuator according to the object value "0" and the set polarity. i This parameter is visible only if automatic heating/cooling is enabled.
	No presence = 1; Presence = 0	<p>This parameter defines the polarity of the object for presence control in case of automatic heating/cooling. This object is linked, for example, with presence detectors.</p> <ul style="list-style-type: none"> i The heating/cooling presence control is initialised after the return of the supply voltage of the actuator according to the object value "0" and the set polarity. i This parameter is visible only if automatic heating/cooling is enabled.
Time delay at the beginning of presence Minutes (0...59)	0...59	<p>The telegram received via the object "Heating/cooling presence" for activation of the presence function (in acc. with polarity) can be evaluated with a time delay.</p> <p>Setting the minutes of the delay time.</p>
Seconds (0...59)	0... 30 ...59	<p>Setting the delay time seconds.</p> <p><i>Presetting: 30 seconds</i></p> <ul style="list-style-type: none"> i A time setting of "0" in the parameters deactivates the respective delay time. In this case, the state of the presence object is evaluated immediately. i These parameters are visible only if automatic heating/cooling is enabled.
Time delay at the end of presence Minutes (0...59)	0...59	<p>The telegram received via the object "Heating/cooling presence" for deactivation of the presence function (in acc. with polarity) can be evaluated with a time delay.</p> <p>Setting the minutes of the delay time.</p>
Seconds (0...59)	0... 30 ...59	<p>Setting the delay time seconds.</p> <p><i>Presetting: 30 seconds</i></p> <ul style="list-style-type: none"> i A time setting of "0" in the parameters deactivates the respective delay time. In this case, the state of the presence object is evaluated immediately. i These parameters are visible only if automatic heating/cooling is enabled.

<p>Reaction at sunshine / shading</p> <p>Beginning with cooling *</p> <p>End with cooling *</p> <p>Beginning with heating *</p> <p>End with heating *</p>	<p>no reaction</p> <p>raising</p> <p>lowering</p> <p>internal scene recall</p> <p>blind or slat position fixed</p>	<p>This parameter defines the behaviour of the output at the end / at the beginning of sunshine / shading with heating / cooling – if applicable, after the end of the delay time.</p> <p>The relays of the output show no reaction. Any travel movements still in progress at this instant will still be finished.</p> <p>The actuator raises the curtain.</p> <p>The actuator lowers the curtain.</p> <p>An internal scene of the actuator is recalled.</p> <p>At the end of shading, the output moves to a parameterized fixed blind and slat position.</p> <p>i This parameter is visible only if automatic heating/cooling is enabled.</p> <p>i This parameter is visible only in the 'Blind' mode of operation.</p> <p>i *: The parameter settings for heating or cooling or beginning or end must be parameterized separately. The setting options - also for the follow-up parameters - are identical in all cases.</p>
<p>Reaction at sunshine / shading</p> <p>Beginning with cooling *</p> <p>End with cooling *</p> <p>Beginning with heating *</p> <p>End with heating *</p>	<p>no reaction</p> <p>raising</p> <p>lowering</p> <p>internal scene recall</p> <p>fixed shutter / awning position</p>	<p>This parameter defines the behaviour of the output at the end / at the beginning of sunshine / shading with heating / cooling – if applicable, after the end of the delay time.</p> <p>The relays of the output show no reaction. Any travel movements still in progress at this instant will still be finished.</p> <p>The actuator raises the curtain.</p> <p>The actuator lowers the curtain.</p> <p>An internal scene of the actuator is recalled.</p> <p>The output moves to a parameterized fixed shutter or awning position.</p>

<p>Reaction at sunshine / shading</p> <p>Beginning with cooling *</p> <p>End with cooling *</p> <p>Beginning with heating *</p> <p>End with heating *</p>	<p>no reaction</p> <p>opening the louver</p> <p>closing the louver</p> <p>internal scene recall</p> <p>venting louver position fixed</p>	<p>no reaction</p> <p>The relays of the output show no reaction. Any travel movements still in progress at this instant will still be finished.</p> <p>The actuator opens the venting louver.</p> <p>The actuator closes the venting louver.</p> <p>An internal scene of the actuator is recalled.</p> <p>At the end of shading, the output moves to a parameterized fixed venting louver position.</p>	<p>i This parameter is visible only if automatic heating/cooling is enabled.</p> <p>i This parameter is visible only in the "Shutter / awning" mode of operation.</p> <p>i *: The parameter settings for heating or cooling or beginning or end must be parameterized separately. The setting options - also for the follow-up parameters - are identical in all cases.</p> <p>This parameter defines the behaviour of the output at the end / at the beginning of sunshine / shading with heating / cooling – if applicable, after the end of the delay time.</p>
<p>Scene number (1...8)</p>	<p>1...8</p>	<p>This parameter defines the number of the internal scene which is recalled.</p>	<p>i This parameter is visible only if automatic heating/cooling is enabled.</p> <p>i This parameter is visible only in the "Venting louver" mode of operation.</p> <p>i *: The parameter settings for heating or cooling or beginning or end must be parameterized separately. The setting options - also for the follow-up parameters - are identical in all cases.</p>
<p>Fixed position of blind</p>		<p>The fixed blind position in case of automatic heating/cooling can either be preset statically by a separate</p>	<p>i This parameter is only visible, if the parameter "Reaction in case of sunshine / shading" of the automatic heating/cooling function is set to "internal scene recall".</p>

		parameter or basically remain at the current value.
	as specified by parameter	The parameterized position of the blind will be approached.
	no change in current position	The current position of the blind will be maintained. In this case, the output behaves as if only the slat were positioned.
		<ul style="list-style-type: none"> i This parameter is only visible, if the blind is to approach a fixed position in case of automatic heating/cooling. i This parameter is visible only in the 'Blind' mode of operation.
Position of blind (0...100 %)	0... 50 ...100	<p>This parameter sets the fixed position of the blind to be approached in case of automatic heating/cooling.</p> <ul style="list-style-type: none"> i This parameter is only visible, if the parameter "Fixed position of blind" is set to "as specified by parameter". i This parameter is visible only in the 'Blind' mode of operation.
Fixed position of slat (0...100 %)	0... 50 ...100	<p>This parameter sets the fixed position of the slat to be approached in case of automatic heating/cooling and, as the case may be, after positioning of the blind.</p> <ul style="list-style-type: none"> i This parameter is only visible, if the slat is to approach a fixed position with automatic heating/cooling. i This parameter is visible only in the 'Blind' mode of operation.
Fixed position of shutter / awning		<p>The fixed shutter/awning position in case of automatic heating/cooling can either be preset statically by a separate parameter or basically remain at the current value.</p>
	as specified by parameter	The parameterized shutter / awning position will be approached.
	no change in current position	The current shutter / awning position will be maintained.
		<ul style="list-style-type: none"> i This parameter is only visible, if the shutter or awning is to approach a fixed position in case of automatic heating/cooling. i This parameter is visible only in the "Shutter / awning" mode of operation.
Position of shutter / awning (0...100 %)	0... 50 ...100	<p>This parameter sets the fixed position of the blind to be approached with automatic heating/cooling.</p>

Fixed position of venting louver	as specified by parameter	<p>i This parameter is only visible, if the parameter "Fixed position of shutter / awning" is set to "as specified by parameter".</p> <p>i This parameter is visible only in the "Shutter / awning" mode of operation.</p> <p>The fixed venting louver position in case of automatic heating/cooling can either be preset statically by a separate parameter or basically remain at the current value.</p>
	no change in current position	<p>The parameterized venting louver position will be approached.</p> <p>The current position of the venting louver will be maintained.</p> <p>i This parameter is only visible, if the venting louver is to approach a fixed position in case of automatic heating/cooling.</p> <p>i This parameter is visible only in the "Venting louver" mode of operation.</p>
Position of venting louver (0...100 %)	0... 50 ...100	<p>This parameter sets the fixed position of the venting louver to be approached in case of automatic heating/cooling.</p> <p>i This parameter is only visible, if the parameter "Fixed position of venting louver" is set to "as specified by parameter".</p> <p>i This parameter is visible only in the "Venting louver" mode of operation.</p>
☐ Ax - Scene (x = number of output)		
Delay scene recall ?	Yes No	<p>A scene is recalled via the scene extension object. If needed, the scene recall on the actuator can be made with a delay after reception of a recall telegram (setting: "Yes"). The recall is alternatively made immediately on reception of the telegram (setting: "No").</p> <p>i A recall delay has no influence on the storage of scene values.</p>
Delay time Minutes (0...59)	0...59	<p>This parameter is used for programming the duration of the delay time for a scene recall.</p>
Seconds (0...59)	0... 10 ...59	<p>Set the delay time minutes.</p> <p>Sets the delay time seconds.</p> <p><i>Presetting: 10 seconds</i></p> <p>i The delay time parameters are only visible, if the parameter "Delay scene recall ?" is set to "yes".</p>
Overwrite values stored in the device during an ETS download ?	Yes no	<p>During storage of a scene, the scene values (current states of the outputs concerned) are stored internally in the device. To prevent the stored values</p>

<p>Scene X can be activated by scene number (scene number "0" = scene deactivated)</p> <p><i>X = depending on the scene (1...8)</i></p>	<p>0...1*...64</p> <p><i>*: The predefined scene number is dependent on the scene (1...8).</i></p>	<p>from being replaced during an ETS programming operation by the originally programmed scene states, the actuator can inhibit overwriting of the scene values (setting: "No"). As an alternative, the original values can be reloaded into the device during each ETS programming operation (setting: "Yes").</p> <p>The actuator distinguishes between up to 8 different scenes which are recalled via the scene extension object or stored. The datapoint type of the extension object, however, permits addressing a maximum of 64 scenes. This parameter defines the scene number (1...64) which is used to address the internal scene (1...8). A setting of "0" deactivates the corresponding scene.</p>
<p>Position of blind for scene X</p> <p><i>X = depending on the scene (1...8)</i></p>	<p>0*...100</p> <p><i>*: The predefined position value is dependent on the scene (1...8).</i></p>	<p>This parameter is used for parameterizing the blind position which is executed when the scene is recalled.</p> <p>i This parameter is visible only in the 'Blind' mode of operation.</p>
<p>Position of slat for scene X</p> <p><i>X = depending on the scene (1...8)</i></p>	<p>0*...100</p> <p><i>*: The predefined position value is dependent on the scene (1...8).</i></p>	<p>This parameter is used for parameterizing the slat position which is executed when the scene is recalled.</p> <p>i This parameter is visible only in the 'Blind' mode of operation.</p>
<p>Position of shutter/awning for scene X</p> <p><i>X = depending on the scene (1...8)</i></p>	<p>0*...100</p> <p><i>*: The predefined position value is dependent on the scene (1...8).</i></p>	<p>This parameter is used for parameterizing the shutter or awning position which is executed when the scene is recalled.</p> <p>i This parameter is visible only in the 'Shutter/awning' mode of operation.</p>
<p>Position of venting louver for scene X</p> <p><i>X = depending on the scene (1...8)</i></p>	<p>0*...100</p> <p><i>*: The predefined position value is dependent on the scene (1...8).</i></p>	<p>This parameter is used for parameterizing the venting louver position which is executed when the scene is recalled.</p> <p>i This parameter is visible only in the "Venting louver" mode of operation.</p>
<p>Storage function for scene X</p> <p><i>X = depending on the scene (1...8)</i></p>	<p>Yes</p> <p>No</p>	<p>Setting "yes" enables the storage function of the scene. If the function is enabled, the current position (0...100 %) can be stored internally via the extension object on reception of a storage telegram. If "no" is selected, the storage telegrams are rejected.</p>
<p><input type="checkbox"/> Ax - Forced position (x = number of output)</p> <p>Behaviour at the end of the forced position function</p>		
<p>Tracking the position</p>		
<p>The behaviour of the output at the beginning of a forced position function is directly determined by the forced position telegram. The behaviour of the output at the end of the forced position function can be configured.</p> <p>At the end of the forced position state, the output will be set to the position last</p>		

		existing before the forced position function or to the one tracked internally while the forced position function was active.
	No change	At the end of forced position state, the position last adjusted will not be changed. Thereafter, the output is again enabled.
Behaviour after bus voltage return		The forced position communication object can be initialised after <u>bus</u> voltage return.
	no forced position active	The forced position is deactivated after bus voltage return.
	Forced position on, raising / opening the louvre	After bus voltage return, the forced position is activated and the blind raised or the venting louvre opened.
	Forced position on, lowering / closing the louvre	After bus voltage return, the forced position is activated and the blind lowered or the venting louvre closed.
	State of forced position before bus/sup. fail	After bus voltage return, the forced-position state last selected and internally stored <u>before</u> bus or supply voltage failure will be tracked. An ETS programming operation deletes the stored state (reaction in that case same as with "no forced position active").
		<p>i This parameter is evaluated even after an ETS download of the application or of parameters.</p> <p>i The forced-position parameters are only visible if the parameter "Forced-position function" under "Ax - enabled functions" is set to "enabled".</p>
<p><input type="checkbox"/> Ax - Fabric-stretching (x = number of output / Only visible for the supplementary function "Fabric-stretching".)</p>		
Time for fabric stretching Seconds (0...59)	0...1...59	This parameter can be used to specify the time for fabric stretching. After the end of a downward travel the awning stops and – after elapsing of the switchover delay – moves backwards in opposite direction for a period corresponding to the fabric stretching time configured here. Setting of the fabric stretching time in seconds.
Milliseconds (0...9 x 100)	0...9	Setting of the fabric stretching time in milliseconds. The time for fabric stretching must be less than the movement time of the roller shutter/awning.

5 Appendix

5.1 Index

A		R	
as-delivered state.....	86	Reference movement.....	41
Automatic heating/cooling.....	73		
B		S	
blinds.....	37	Safe-state mode.....	17
bus voltage failure.....	31	safety functions.....	47
		Safety functions cyclical monitoring.....	30
C		Safety functions presetting priorities.....	29
Central function.....	24	Safety functions:.....	28
Commissioning.....	10	scene numbers.....	80
Computing.....	37	scene recall delay.....	79
Controls and indicators.....	11	short-time.....	34
		Simple sun protection.....	50
D		slat moving time.....	36
Delay.....	24	Slat offset.....	65
Determining.....	35	Status LED.....	5
		Sun protection function.....	50
E		supply voltage.....	31
Enabling the manual control mode.....	25	switchover time.....	37
ETS	17		
ETS search paths.....	15		
extended sun protection.....	52		
F			
Fabric-stretching.....	84		
Forced position function.....	81		
L			
Light scene function.....	79		
long-time.....	34		
Long-time operation.....	34		
M			
Manual control behaviour at beginning..	26		
and end			
manual control disable.....	27		
Manual control status message.....	27		
Manual operation.....	25		
movement time extension.....	37		
O			
operating mode.....	31		
P			
Parameter "Safety general".....	87		
Parameter "Safety times".....	88		
Parameter Manual control.....	90		
Position feedback messages.....	43		
Presetting the position.....	42		

Gira
Giersiepen GmbH & Co. KG
Elektro-Installations-
Systeme

Industriegebiet Mermbach
Dahlienstraße
42477 Radevormwald

Postfach 12 20
42461 Radevormwald

Deutschland

Tel +49(0)21 95 - 602-0
Fax +49(0)21 95 - 602-191

www.gira.de
info@gira.de