

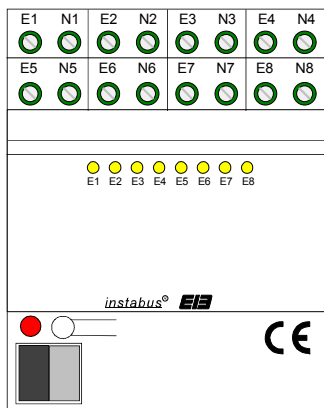

Product name: **binary input 8fold 230 V DRA**
 Design: DRA (series-mounting)
 Item no.: **1069 00**
 ETS search path: Gira Giersiepen / input / binary input, 8fold / binary input 8fold 230 V DRA

Functional description:

With its eight independent inputs, this binary input assembly can collect 230 V signals and send messages to the EIB, depending on the software used. These can, for example, be messages for switching, dimming (also single-button actuation dimming) or for blind/shutter control. Also, it is possible to program certain functions such as dimming transmitters, light scene extensions as well as temperature or brightness transmitters, respectively. Various functions can be assigned to the eight inputs. In addition, inputs 1 and 2 can be parameterised with pulse or switching counter functions. The binary input assembly enables you to specifically inhibit individual inputs.

Layout:**Dimensions:**

Width: 4 PU; 70 mm
 Height: 90 mm
 Depth: 58 mm

PU = partial unit

Controls:

1 programming key
 1 programming LED (red)
 8 LED to indicate the input signals applied (yellow)

Specifications:

External supply ---
 instabus EIB supply
 Voltage: 24 V DC (+6 V / -4 V)
 Power consumption: 240 mW (I = 10 mA) max.
 Connection: instabus connecting and branch terminal

Input

Number: 8
 Signal voltage: 110 V ... 230 V AC \pm 10 %; 50 / 60Hz
 Signal current: approx. 7 mA at 230 V AC per input
 (max. glow discharge lamp current < 2 mA for reliable "0" recognition)
 Input power per channel: approx. 1.6 VA at 230 V AC per input
 Signal length for pulse counting: T_{min.} = 200 ms at a mark-to-space ratio of 1:1
 Signal recognition
 "0" signal: 0 ... 70 V AC
 "1" signal: > 90 V AC
 Signal delay
 Rising edge: approx. 2 ms
 Falling edge: approx. 40 ms
 Input line length: 100 m max. (unshielded)
 Connection: Screw terminals:
 0,75 – 4 mm² single-wire
 2 x 0,75 – 2,5 mm² single-wire
 0,75 – 4 mm² finely stranded without ferrule
 0,75 – 2,5 mm² finely stranded with ferrule

instabus EIB System

Sensor

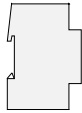

Response to voltage failure

Bus voltage only:	No reaction.
Mains voltage only:	A falling edge is detected. This response depends on the software used.
Bus and mains voltages:	No reaction.

Response to re-closing

Bus voltage only:	Depending on the software used.
Mains voltage only:	A falling edge is detected. This response depends on the software used.
Bus and mains voltages:	Depending on the software used.

Protective system:	IP 20
Mark of conformity:	EIB
Ambient temperature:	-5 °C to +45 °C
Storage temperature:	-25 °C to +75 °C (storage above +45 °C will shorten the life)
Minimum pitch:	none
Type of fixing:	to be snapped onto top hat rail (data rail not required)

Wiring diagram:

Terminal assignment:

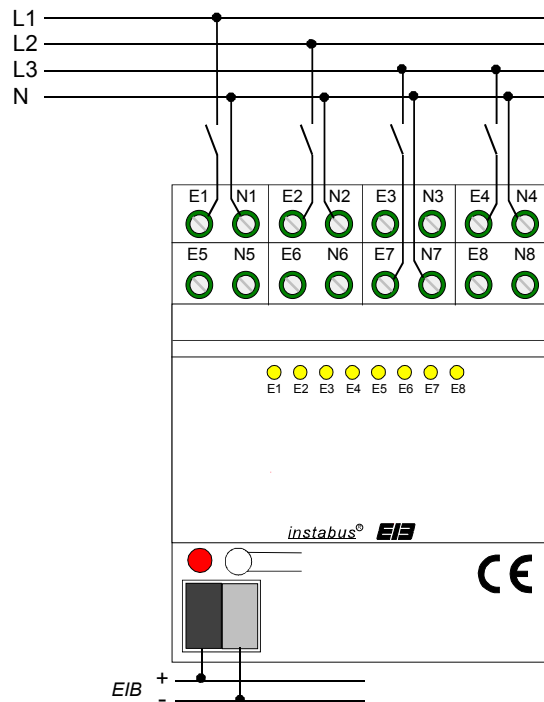

Remarks on the hardware:

- In addition to parameterisable software debouncing of the inputs, all signals always pass through some hardware debouncing. Such signal edge delay depends on the signal amplitude and is approx. 2 ms (rising edge) or approx. 40 ms (falling edge), respectively.
- Three different external conductors can be connected.
- Up to eight different fault current circuits are possible.



Software-Description:

ETS-search path:

Gira Giersiepen / input / binary input, 8fold / binary input 8fold 230 V DRA

ETS-symbol:

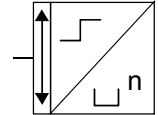

Applications:

Brief description:

Universal input assembly

Name:

universal input 705402

Date:

04.02

Page:

5

Data base

2.51

instabus EIB System

Sensor

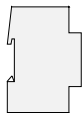



Application: universal input 705402

Scope of functions**General**

- Free assignment of the "switching", "dimming", "shutter", "value transmitter" functions to the eight inputs.
- Free assignment of the "pulse counter" and "switching counter" functions to inputs 1 and 2.
For the "pulse counter" function parameterised for input 1 (2), input 3 (4) will be reserved for the sync signal and, therefore, cannot be used for any other functions.
- Signal indication is possible through eight yellow status LEDs. The status LED will light up when a signal is being applied and cannot be parameterised.
- Inhibit object to disable individual inputs (polarity of the inhibit object adjustable).
- Delay upon bus voltage recovery and debouncing time centrally adjustable.
- Response to bus voltage recovery separately parameterisable for each input.
- Message rate limitation parameterisable, in general, for all inputs.

Switching function

- Two independent switching objects are available for each input and can be isolated individually.
- Command upon rising and falling edges separately selectable (ON, OFF, TOGGLE, no reaction).
- Independent cyclic sending of the switching objects selectable as a function of the edge or of the object value, respectively.

Dimming function

- Single-button or double-button operation possible.
- Time between dimming and switching and dimming step width adjustable.
- Message repetition and sending stop message possible.

Shutter function

- Command upon the rising edge (no function, UP, DOWN, TOGGLE) adjustable.
- Operating concept parameterisable (step – move – step or move - step, respectively).
- Time between step-time mode and move-time mode adjustable (for step – move – step only).
- Blade setting time adjustable (time during which a MOVE command can be completed by releasing a pushbutton at the input).

Value transmitter and light scene extension functions

- Edge (normally-open contact pushbutton, normally-closed contact pushbutton, switch) and value can be parameterised in case of edge mode.
- Value changing for transmitter possible in case of pushbutton mode by pressing pushbutton for a long period.
- For light scene extension with memory function, storage of light scene is also possible without previously calling it.

Temperature transmitter and brightness transmitter functions

- Edge (normally-open contact pushbutton, normally-closed contact pushbutton, switch) and value can be parameterised in case of edge mode.
- Value changing possible in case of pushbutton mode by pressing pushbutton for a long period.

Pulse counter function

- Pulse counting edge and count carry-over interval time can be parameterised.
- Count reset sync signal edge and switch message upon arrival of the sync signal adjustable as a function of the edge.

Switching counter function

- Edge for counting the signals at the input and maximum count are selectable.
- Step width for count read-out and command (no message, ON, OFF, TOGGLE) upon reaching maximum count can be parameterised.

instabus EIB System

Sensor

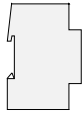

Objects	Object description
□ 0 – 7 switching	1 bit object for sending switch messages (ON, OFF).
□ 8 – 15 dimming	4 bit object for relative brightness changing between 0 and 100 %.
□ 0 – 7 step modus	1 bit object for the short-time mode of a blind/shutter.
□ 8 – 15 move modus	1 bit object for the long-time mode of a blind/shutter.
□ 0 – 7 value	1 byte object for sending value messages (0 - 255), for example.
□ 0 – 7 light scene extension unit	1 byte object for calling or saving light scenes (1 - 128).
□ 8 – 15 temperature value	2 byte object for setting a fixed temperature value (0 - 40 °C).
□ 8 – 15 brightness value	2 byte object for setting a fixed brightness value (0 - 1500 lux).
□ 2, 3 syn. signal pulse counter X	1 bit object for sending switch messages as a function of the sync signal.
□ 8, 9 counter status pulse counter X	2 byte object for carrying over the count.
□ 0, 1 switching counter	1 bit object for sending switch messages as a function of the count.
□ 8, 9 switching counter	2 byte object for carrying over the count.
□ 16 – 23 blocking	1 bit object for inhibiting individual inputs.



Transmitter: Setting by long-time pushbutton actuation

If you have parameterised a transmitter (normal transmitter, temperature or brightness transmitter), you can set the value to be sent by short-time pushbutton actuation (> 5 s), if the value is to be sent upon the rising or falling edge. In this case, the programmed value will be increased by the parameterised step width and sent. After the input is released, the value sent last will be kept stored. The next long-time pushbutton actuation will change the value setting direction.

Transmitter example:

Dimming value (0...255) 17
Step width (1...10) 5

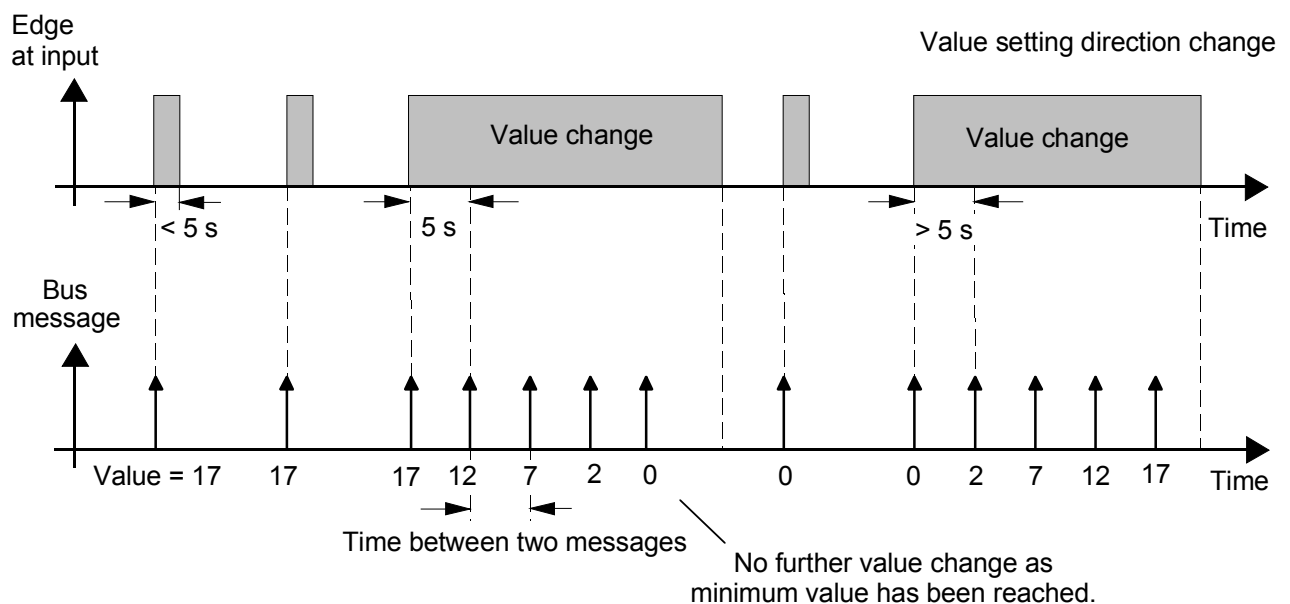

Important:

There will be no value setting overflow. If the maximum (255) or minimum (0) value is reached during setting, no more messages will be sent.

Sensor

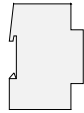

Light scene extension with/without memory function:

If you have parameterised a light scene extension without memory function you can call a light scene. The parameterised light scene number will be sent immediately upon the rising, falling, or rising and falling edges, respectively.

If you have parameterised a light scene extension with memory function, you can generate a save message of the light scene to be sent. The corresponding save message will be sent upon long-time actuation of the normally open contact (rising edge) or of the normally closed contact (falling edge). In this case, the time for long-time actuation can be parameterised (however, not below 5 s). Short-time actuation of < 1 s will cause the parameterised light scene number to be sent (without save message). If the actuation is longer than 1 s and shorter than 5 s, no message will be released. In addition, you can send a save message only without previously calling a light scene. In such case, parameter "memory function only = YES" must have been set.

Example of a light scene extension with memory function:

- 1.) Memory function only = NO
- 2.) Memory function only = YES

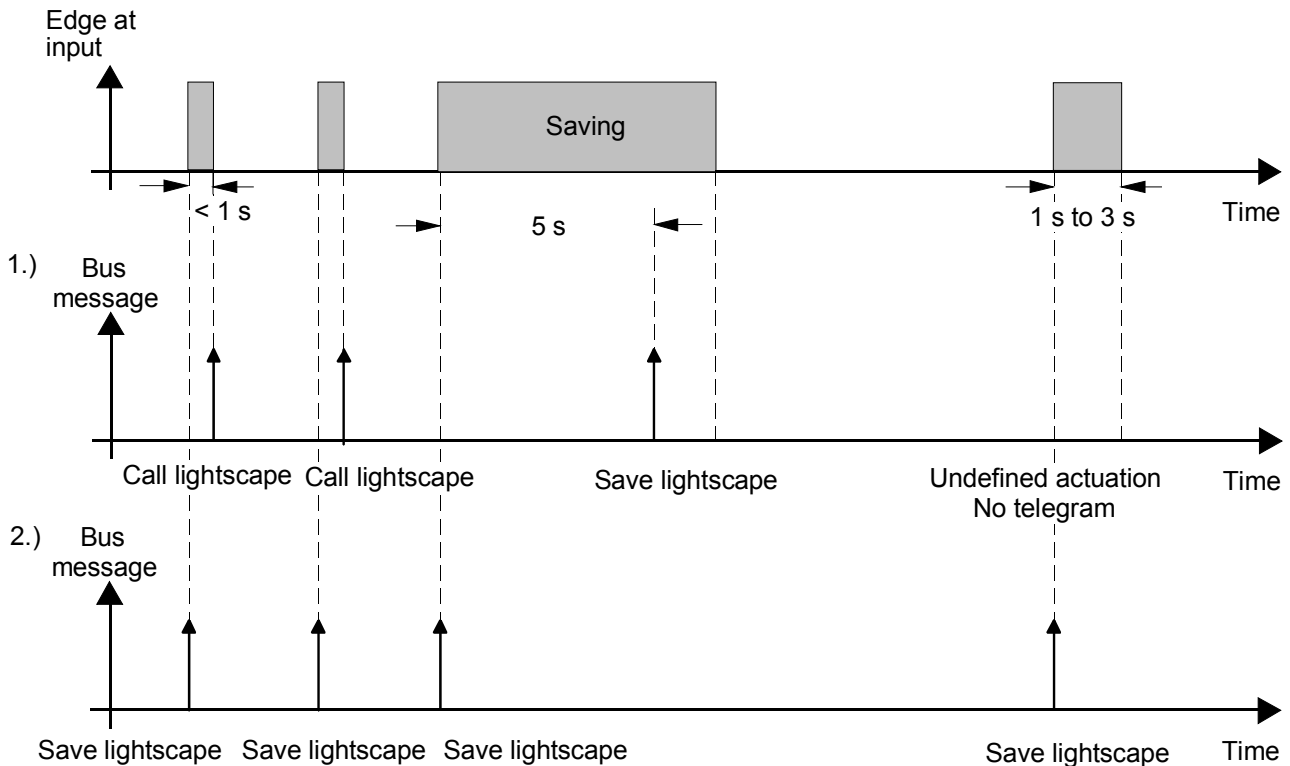

Memory function only = NO:

If a rising or falling edge is recognised at the input (depending on parameterisation), the timer will start. If you release the pushbutton within the first second, the corresponding light scene will be called immediately. If actuation lasts longer, the save message will be sent after 5 s.

Memory function only = YES:

Immediately upon the recognition of the corresponding edge, the save message will be sent.



Pulse counter:

The pulse counters can only be parameterised to input 1 or 2. In this case, inputs 3 (for pulse counter 1) or 4 (for pulse counter 2) are the sync signal inputs and cannot be assigned to any other function. Pulse counters 1 and 2 run independently of each other and have a resolution of 16 bit so that counts between 0 and 65535 are possible. You can set the L-flag to read out the current count at object 8 or 9, respectively.

The counting pulse is applied to input 1 or 2, respectively. After the interval time specified as parameter has elapsed, the count will be taken over and sent as object value of the 2 byte "count" object (object 8 or 9). Then the 2 byte pulse counter will be internally reset during the next time interval.

Only upon the appearance of a new edge at the input, or after the newly started interval time has elapsed, the current count can be read out from the count objects (set L-flag).

In addition, the count and the interval time can be reset by a sync signal applied to input 3 or 4, respectively. Moreover, switch messages (no message, ON, OFF, TOGGLE) can be sent in dependence of the sync signal edge. The output value can be assigned to the edge. The edge assignment for resetting the count can be parameterised independently of the output value.

For pulse counting, the mark-to-space time of a signal applied to input 1 or 2 must not fall below 100 ms. Disabling the pulse counter will not be possible.

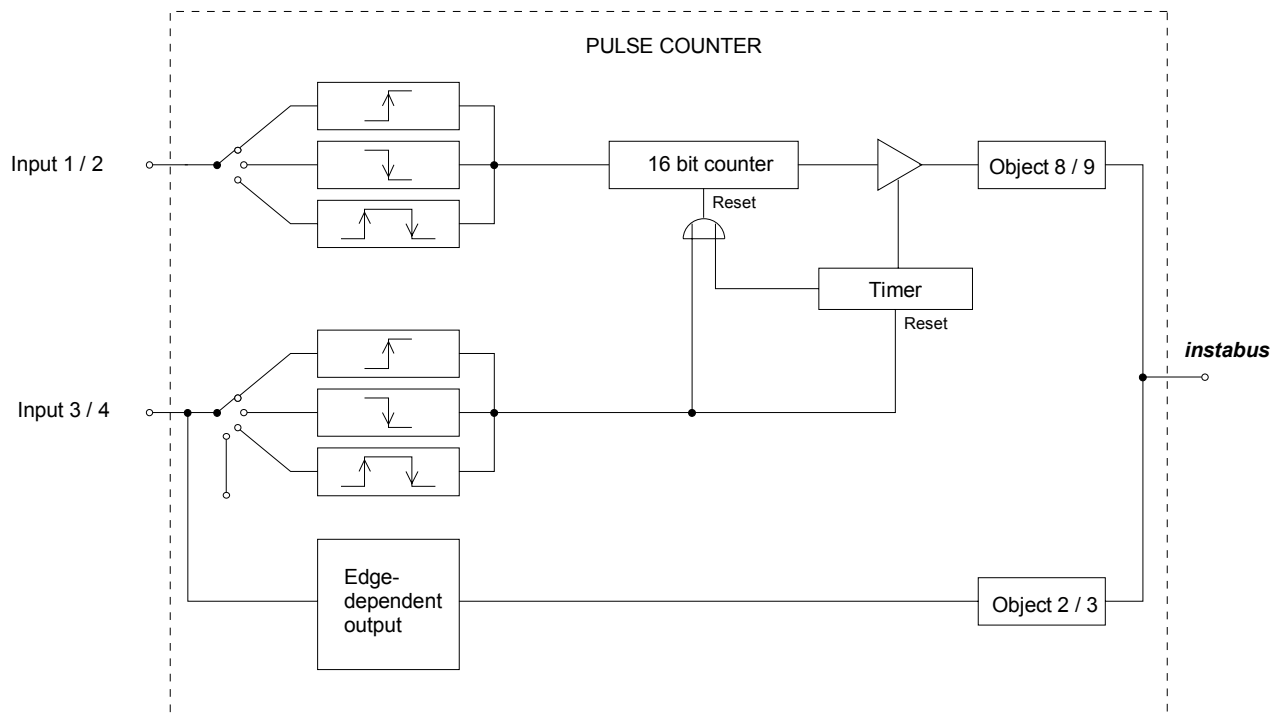

Sensor

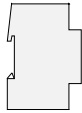

Switching counter:

The switching counters can only be parameterised to input 1 or 2. Switching counters 1 and 2 run independently of each other and have a resolution of 16 bit so that counts between 1 and 65535 are possible. You can set the L-flag to read out the current count at object 8 or 9, respectively.

The counting pulse is applied to input 1 or 2, respectively. After the count has reached the parameterised set value, it will be taken over into 2 byte object 8 or 9 and transmitted. In this connection, it will be possible to output a signal value (1 bit object "0" or "1", respectively) which can be parameterised. After the transmission, the 16 bit counter will be automatically and internally reset. Only upon the appearance of a new edge at the input, the current count can be read out from the count objects (set L-flag)

Moreover, the count will be sent in cycles after a pre-defined number of counting pulses (1...255).

For switch-event counting, the mark-to-space time of a signal applied to input 1 or 2 must not fall below 100 ms.

Disabling the switching counter will not be possible.

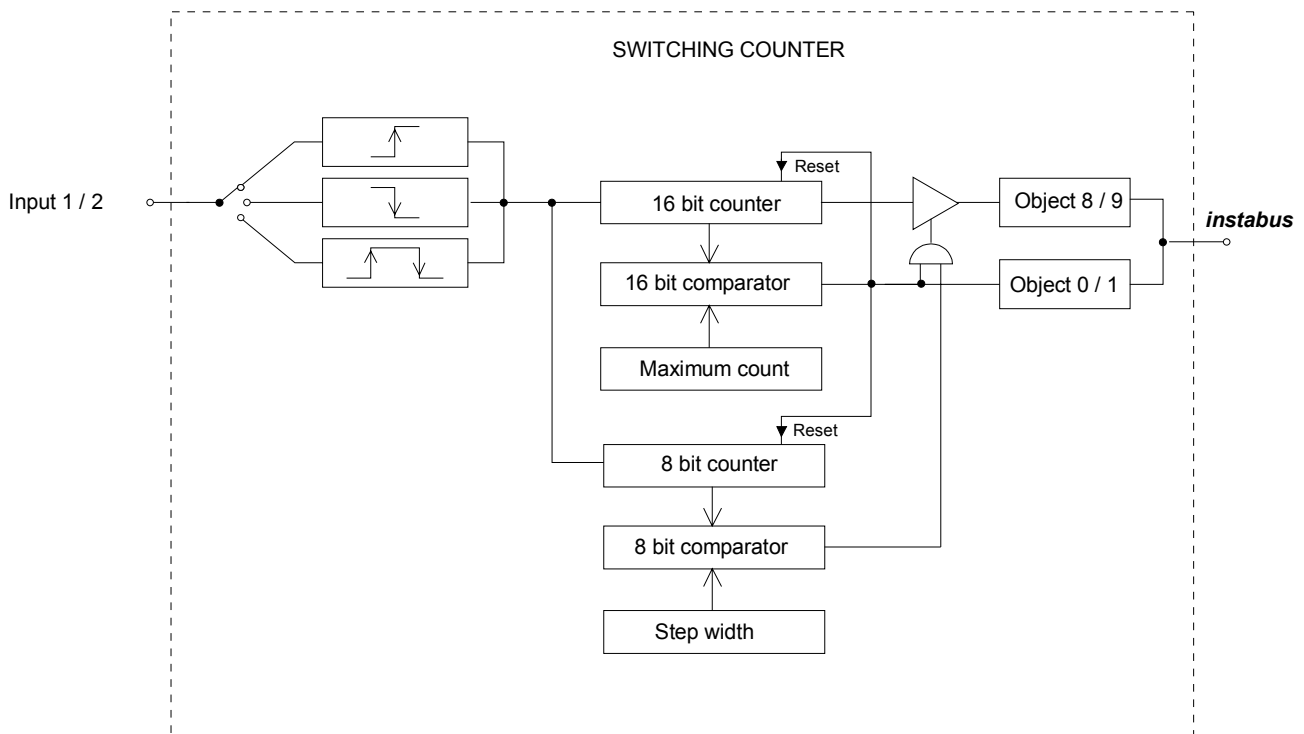



Sensor

Number of addresses (max.):	26	dynamic table management:	Yes <input checked="" type="checkbox"/>	No <input type="checkbox"/>
Number of assignments (max.):	27	maximum table length:	53	
Communication objects:	24			

Function: switching (for all 8 inputs **)

Object:	Function:	Name:	Type:	Flag:
<input type="checkbox"/> 0 – 7	switching	input 1 – 8	1 bit	S,K,Ü,(L)*

Function: dimming (for all 8 inputs **)

Object:	Function:	Name:	Type:	Flag:
<input type="checkbox"/> 0 – 7	switching	input 1 – 8	1 bit	S,K,Ü,(L)*
<input type="checkbox"/> 8 – 15	dimming	input 1 – 8	4 bit	K,Ü,(L)*

Function: shutter (for all 8 inputs **)

Object:	Function:	Name:	Type:	Flag:
<input type="checkbox"/> 0 – 7	step modus	input 1 – 8	1 bit	K,Ü,(L)*
<input type="checkbox"/> 8 – 15	move modus	input 1 – 8	1 bit	K,Ü,(L)*

Function: value transmitter (dimming value transmitter for all 8 inputs **)

Object:	Function:	Name:	Type:	Flag:
<input type="checkbox"/> 0 – 7	value	input 1 – 8	1 byte	K,Ü,(L)*

Function: value transmitter (call light scenes with / without memory function for all 8 inputs **)

Object:	Function:	Name:	Type:	Flag:
<input type="checkbox"/> 0 – 7	light scene extension unit	input 1 – 8	1 byte	K,Ü,(L)*

Function: value transmitter (temperature value transmitter for all 8 inputs **)

Object:	Function:	Name:	Type:	Flag:
<input type="checkbox"/> 8 – 15	temperature value	input 1 – 8	2 byte	K,Ü,(L)*

Function: value transmitter (brightness value transmitter for all 8 inputs **)

Object:	Function:	Name:	Type:	Flag:
<input type="checkbox"/> 8 – 15	brightness value	input 1 – 8	2 byte	K,Ü,(L)*

Function: pulse counter (for inputs 1 and 2 ***)

Object:	Function:	Name:	Type:	Flag:
<input type="checkbox"/> 2	syn. signal pulse counter 1	input 3	1 bit	S,K,Ü,(L)*
<input type="checkbox"/> 3	syn. signal pulse counter 2	input 4	1 bit	S,K,Ü,(L)*
<input type="checkbox"/> 8	counter status pulse counter 1	input 1	2 byte	K,Ü,(L)*
<input type="checkbox"/> 9	counter status pulse counter 2	input 2	2 byte	K,Ü,(L)*

Function: switching counter (for inputs 1 and 2 ***)

Object:	Function:	Name:	Type:	Flag:
<input type="checkbox"/> 0	switching counter	input 1	1 bit	S,K,Ü,(L)*
<input type="checkbox"/> 1	switching counter	input 2	1 bit	S,K,Ü,(L)*
<input type="checkbox"/> 8	switching counter	input 1	2 byte	K,Ü,(L)*
<input type="checkbox"/> 9	switching counter	input 2	2 byte	K,Ü,(L)*

Function: Blocking (for all 8 inputs ****)

Object:	Function:	Name:	Type:	Flag:
<input type="checkbox"/> 16 – 23	blocking	input 1 – 8	1 bit	S,K,(L)*

* For the objects marked (L) the current status can be read out (set L flag).

** The "no function", "switching", "dimming", "shutter" and "value transmitter" functions can be selected per input. The names of the communication objects and the object table (dynamic object structure) will change correspondingly.

*** The "pulse counter" and "switching counter" functions can only be parameterised for inputs 1 and 2. For the "pulse counter" function parameterised for input 1 (2), input 3 (4) will be reserved for the sync signal and, therefore, cannot be used for any other functions.

**** If the inputs have been parameterised to "no function", "pulse counter" or "switching counter", no inhibit function will be possible.



Parameters		
Description:	Values:	Comment:
General		
delay at bus voltage return base	130 ms, 260 ms, 520 ms, 1 s 2,1 s, 4,2 s, 8,4 s, 17 s, 34 s 1,1 min, 2,2 min, 4,5 min, 9 min 18 min, 35 min, 1,2 h	Upon bus voltage recovery, the binary input can be inhibited for a defined time until the corresponding response is made. During this period, any signals applied to the inputs will not be accepted. Time = base · factor
delay at bus voltage return factor (3...127)	3 to 127 (Default 17)	Upon bus voltage recovery, the binary input can be inhibited for a defined time until the corresponding response is made. During this period, any signals applied to the inputs will not be accepted. Time = base · factor Presetting: 1 s · 17 = 17 s
debounce time factor (0...255) * 0,5 ms	0 to 255 (Default 10)	It specifies the software debouncing. The time parameterised here represents the signal edge delay in addition to the delay fixed by the hardware. Time = 0.5 ms · factor Presetting: 0.5 ms · 10 = 5 ms
telegram rate limitation	released locked	The message rate limitation can be disabled or enabled. If message rate limitation has been enabled, absolutely no messages will be sent within the first 17 s after bus voltage recovery.
telegrams per 17 sec.	30 60 100 127	If message rate limitation has been enabled, the maximum number of messages within 17 s can be set here.



Input 1		
function input 1	no function switching dimming shutter value transmitter pulse counter switching counter	It specifies the function of input 1.
Function input 1= "no function"		
		No further parameters.
Function input 1 = "switching"		
command on rising edge switching object 1.1	no reaction ON OFF TOGGLE	It specifies the command to be sent through switching object 1.1 upon a rising edge. Upon " TOGGLE", the object value will be changed over
command on falling edge switching object 1.1	no reaction ON OFF TOGGLE	It specifies the command to be sent through switching object 1.1 upon a falling edge. Upon " TOGGLE ", the object value will be changed over.
command on rising edge switching object 1.2	no reaction ON OFF TOGGLE	It specifies the command to be sent through switching object 1.2 upon a rising edge. Upon " TOGGLE", the object value will be changed over
command on falling edge switching object 1.2	no reaction ON OFF TOGGLE	It specifies the command to be sent through switching object 1.2 upon a falling edge. Upon " TOGGLE ", the object value will be changed over.



<p> Input 1</p>		
<p> Function input 1 = "switching"</p>		
<p>behaviour on bus voltage return</p>	<p>no reaction</p> <p>transmit current input status</p> <p>Send ON-telegram</p> <p>Send OFF-telegram</p>	<p>You can specify what response is to be made upon bus voltage recovery. If some delay after bus voltage recovery has been parameterised, this time will first have to have elapsed until the response specified here will be made.</p> <p>No response will be made.</p> <p>The current status of the inputs according to the parameterisation for the rising and falling edges will be sent.</p> <p>A forced ON will be sent.</p> <p>A forced OFF will be sent.</p>
<p>cyclical transmission ?</p>	<p>no cyclical transmission</p> <p>repeat at ON</p> <p>repeat at OFF</p> <p>repeat at ON and OFF</p>	<p>Via the switching objects, cyclic sending can be effected, depending on the object value.</p> <p>No cyclic sending will be effected.</p> <p>Cyclic sending will be effected if the object value is "ON".</p> <p>Cyclic sending will be effected if the object value is "OFF".</p> <p>Cyclic sending will always be effected, independently of the object value.</p>
<p>time base for cyclical transmission switching object 1.1</p>	<p>1 s, 2,1 s, 4,2 s, 8,4 s, 17 s, 34 s 1,1 min, 34 s, 1,1 min, 2,2 min 4,5 min, 9 min, 18 min, 35 min 1,2 h</p>	<p>Specifies the time base for cyclic sending via switching object 1.1.</p> <p>Time = base · factor</p>
<p>time base for cyclical transmission switching object 1.2</p>	<p>1 s, 2,1 s, 4,2 s, 8,4 s, 17 s, 34 s 1,1 min, 34 s, 1,1 min, 2,2 min 4,5 min, 9 min, 18 min, 35 min 1,2 h</p> <p>no cyclical transmission by switching object X.2</p>	<p>Specifies the time base for cyclic sending via switching object 1.2. Cyclic sending via switching object 1.2 can be inhibited if "no cyclic sending via switching object X.2" is selected.</p> <p>Time = base · factor</p>
<p>time factor for cyclical transmission switching object 1.1 and 1.2 (3...127)</p>	<p>3 to 127 (Default 60)</p>	<p>Specifies the time factor for cyclic sending via both switching objects.</p> <p>Time = base · factor</p> <p>Presetting: 1 s · 60 = 60 s</p>



Input 1, blocking ["switching"]		
blocking function	released locked	The inhibit function can be disabled or enabled.
polarity blocking object	blocking = 1 (release = 0) blocking = 0 (release = 1)	This parameter specifies the polarity of the inhibit object.
behaviour at begin of blocking switching object 1.1 and 1.2	no reaction ON OFF TOGGLE	In case of active inhibition, both switching objects will be inhibited. This parameter specifies the command which will be sent through both switching objects at the beginning of the inhibition. Upon "TOGGLE", the object values will be changed over.
behaviour at end of blocking switching object 1.1 and 1.2	no reaction ON OFF transmit current input status	In case of active inhibition, both switching objects will be inhibited. This parameter specifies the command which will be sent through both switching objects at the end of the inhibition. Upon "transmit current input status", the current status of the inputs according to the parameterisation for the rising and falling edges will be sent.
Input 1		
Function input 1 = "dimming"		
operation	single contact using: darker/brighter (toggle) double contact using: brighter (ON)	Specifies the response to a rising edge at the input. Short-time actuation of a pushbutton at the input will change over the value of the switching object, with a corresponding message being sent. Long-time actuation will release a dim message (brighter/darker). The dimming direction will be saved exclusively internally and changed over for successive dimming events. Short-time actuation of a pushbutton at the input will release an ON message, whereas long-time actuation will cause a dim message (brighter).

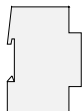

Input 1		
Function input 1 = "dimming"		
operation	<p>double contact using: darker (OFF)</p> <p>double contact using: brighter (TOGGLE)</p> <p>double contact using: darker (TOGGLE)</p>	<p>Short-time actuation of a pushbutton at the input will release an OFF message, whereas long-time actuation will cause a dim message (darker).</p> <p>Short-time actuation of a pushbutton at the input will change over the value of the switching object, with a corresponding message being sent, whereas long-time actuation will cause a dim message (brighter).</p> <p>Short-time actuation of a pushbutton at the input will change over the value of the switching object, with a corresponding message being sent, whereas long-time actuation will cause a dim message (darker).</p>
time between switching and dimming base	<p>130 ms</p> <p>260 ms</p> <p>520 ms</p> <p>1 s</p>	<p>Time from which on the dimming function ("long-time actuation") will be executed.</p> <p>Time = base · factor</p>
time between switching and dimming factor (4...127)	<p>4 to 127 (Default 4)</p>	<p>Time from which on the dimming function ("long-time actuation") will be executed.</p> <p>Time = base · factor</p> <p>Presetting: 130 ms · 4 = 520 ms</p>
behaviour on bus voltage return	<p>no reaction</p> <p>send ON-telegram</p> <p>send OFF-telegram</p>	<p>You can specify what response is to be made upon bus voltage recovery. If some delay after bus voltage recovery has been parameterised, this time will first have to have elapsed until the response specified here will be made.</p> <p>No response.</p> <p>A forced ON will be sent.</p> <p>A forced OFF will be sent.</p>
dimming brighter by	<p>100 % 6 %</p> <p>50 % 3 %</p> <p>25 % 1,5 %</p> <p>12,5 %</p>	<p>With a dim message, you can dim up by a maximum of X %. This parameter specifies the maximum dimming step width of a dim message. This parameter depends on the type of operation set.</p>



Input 1		
Function input 1 = "dimming"		
dimming darker by	100 % 50 % 25 % 12,5 %	6 % 3 % 1,5 %
send stop telegram ?	YES NO	Releasing a pushbutton at the input (falling edge) will cause a stop message or no stop message to be sent.
telegram repeat ?	YES NO	Cyclic message repetition during long-time actuation.
time between two telegrams base	130 ms 260 ms 520 ms 1 s	Time between two messages when message repetition has been set. Each time this period has elapsed, a new dim message will be sent. For message repetition only? = "YES". Time = base · factor
time between two telegrams factor (3...127)	3 to 127 (default 10)	Time between two messages when message repetition has been set. Each time this period has elapsed, a new dim message will be sent. For message repetition only? = "YES". Time = base · factor Presetting: 130 ms · 10 = 1.3 ms
Input 1, blocking ["dimming"]		
blocking function	released locked	The inhibit function can be disabled or enabled.
polarity blocking object	blocking = 1 (release = 0) blocking = 0 (release = 1)	This parameter specifies the polarity of the inhibit object.
behaviour at begin of blocking	no reaction ON OFF TOGGLE	This parameter specifies the command which will be sent through the switching object at the beginning of the inhibition. Upon "TOGGLE", the object values will be changed over.
behaviour at end of blocking	no reaction OFF	This parameter specifies the command which will be sent through the switching object at the beginning of the inhibition.

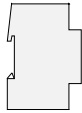

Input 1		
Function input 1 = "shutter"		
command on rising edge	no function UP DOWN TOGGLE	<p>Specifies the response to a rising edge at the input.</p> <p>The input is deactivated.</p> <p>Short-time pushbutton actuation will release a STEP message (UP), whereas long-time actuation will cause a MOVE message (UP).</p> <p>Short-time pushbutton actuation will release a STEP message (DOWN), whereas long-time actuation will cause a MOVE message (DOWN).</p> <p>This setting enables the moving direction to be internally changed upon each long-time actuation (MOVE). If a short-time actuation causes a STEP message to be sent, such STEP will always be opposite to the last MOVE message. Several successive STEP messages will have the same direction.</p>
behaviour on bus voltage return	no reaction UP DOWN	<p>You can specify what response is to be made upon bus voltage recovery. If some delay after bus voltage recovery has been parameterised, this time will first have to have elapsed until the response specified here will be made.</p> <p>No response.</p> <p>A forced MOVE (UP) will be sent.</p> <p>A forced MOVE (DOWN) will be sent.</p>



<p>Input 1</p> <p>Function input 1 = "shutter"</p>		
<p>operating concept</p>	<p>step – move - step</p> <p>move - step</p>	<p>Specifies the message sequence after an actuation (rising edge).</p> <p>step – move – step:</p> <p>A rising edge will send a STEP message and start time T1 (time between short-time and long-time mode). This STEP serves for stopping an ongoing continuous run. If a falling edge is detected within T1, the binary input will send no further message.</p> <p>If no falling edge is detected during T1, the binary input will automatically send a MOVE message after T1 has elapsed and will start T2 (blade adjusting time). If a falling edge is then detected within T2, the binary input will send a STEP message. This function can be used for blade adjustment. T2 should correspond to a 180° blade rotation.</p> <p>move – step:</p> <p>A rising edge at the input will send a MOVE message and start time T1 (blade adjusting time). If a falling edge is detected within T1, the binary input will send a STEP message. This function can be used for blade adjustment. T1 should correspond to a 180° blade rotation.</p>

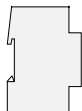

Input 1		
Function input 1 = "shutter"		
time between step and move base	130 ms 260 ms 520 ms 1 s 2,1 s 4,2 s	8,4 s 17 s 34 s 1,1 min 34 s Time = base · factor
time between step and move factor (4...127)	4 to 127 (Default 4)	Time from which on the function of a long-time actuation will be executed. Only for operation concept = "step – move – step". Time = base · factor Presetting: 130 ms · 4 = 520 ms
lamellae adjusting time base	130 ms 260 ms 520 ms 1 s 2,1 s 4,2 s	8,4 s 17 s 34 s 1,1 min 34 s Time = base · factor
lamellae adjusting time factor (3...127)	3 to 127 (Default 20)	Time during which you can terminate a blade adjusting MOVE message by releasing the pushbutton at the input. Time = base · factor Presetting: 130 ms · 20 = 2.6 ms
Input 1, blocking ["shutter"]		
blocking function	released locked	The inhibit function can be disabled or enabled.
polarity blocking object	blocking = 1 (release = 0) blocking = 0 (release = 1)	This parameter specifies the polarity of the inhibit object.
behaviour at begin of blocking	no reaction DOWN UP TOGGLE	This parameter specifies the command which will be sent through the long-time object at the beginning of the inhibition. Upon " TOGGLE", the (internally saved) moving direction executed last will be changed.
behaviour at end of blocking	no reaction DOWN UP TOGGLE	This parameter specifies the command which will be sent through the long-time object at the end of the inhibition. Upon " TOGGLE", the (internally saved) moving direction executed last will be changed.



Input 1		
Function input 1 = "value transmitter"		
function as	'dimming value transmitter' call light scenes without memory function call light scenes with memory function temperature value transmitter brightness value transmitter	Specifies the function to be executed.
value transmitter = "dimming value transmitter"		
transmit value at	rising edge (pushbutton normally closed contact) falling edge (pushbutton normally closed contact) rising and falling edges (switch)	Specifies the edge which will initiate an event.
value at rising edge (0...255)	0 to 255 (Default 100)	Specifies the value which will be sent upon a rising edge. Only for "transmit value at = rising edge (pushbutton normally open contact)" and "transmit value at = rising and falling edges (switch)".
value at falling edge (0...255)	0 to 255 (Default 0)	Specifies the value which will be sent upon a falling edge. Only for "transmit value at = rising edge (pushbutton normally closed contact)" and "transmit value at = rising and falling edges (switch)".



Input 1		
Function input 1 = " dimming value transmitter "		
behaviour on bus voltage return	<p>no reaction</p> <p>reaction like rising edge</p> <p>reaction like falling edge</p> <p>transmit current input status</p>	<p>You can specify what response is to be made upon bus voltage recovery. If some delay after bus voltage recovery has been parameterised, this time will first have to have elapsed until the response specified here will be made.</p> <p>No response.</p> <p>The value parameterised for the rising edge will be forced to be sent.</p> <p>Only for "transmit value at = rising edge (pushbutton normally open contact)" and "transmit value at = rising and falling edges (switch)".</p> <p>The value parameterised for the falling edge will be forced to be sent.</p> <p>Only for "transmit value at = falling edge (pushbutton normally closed contact)" and "transmit value at = rising and falling edges (switch)".</p> <p>The current status of the inputs according to the parameterisation for the rising and falling edges will be sent.</p> <p>Only for "transmit value at = rising and falling edges (switch)".</p>
control by long actuation?	<p>YES</p> <p>NO</p>	<p>Upon a long-time actuation (< 5 s), the current value can be sent in a cyclic manner decreased or increased by the parameterised step width (see below). After this value change, the value sent last will remain saved. This parameter determines whether value changing will be possible.</p> <p>Only for "transmit value at = rising edge (pushbutton normally open contact)" and "transmit value at = falling edge (pushbutton normally closed contact)".</p>
time between two telegrams base	<p>130 ms</p> <p>260 ms</p> <p>520 ms</p> <p>1 s</p>	<p>Time base between two cyclic messages for value changing.</p> <p>Only for "control by long actuation? = YES".</p>



Input 1		
Function input 1 = "dimming value transmitter"		
time between two telegrams factor (3...127)	3 to 127 (Default 3)	Time factor between two cyclic messages for value changing. Only for "control by long actuation? = YES". Time = base · factor Presetting: 520 ms · 3 = 1.56 s
step size (1...10)	1 to 10 (Default 10)	Step width by which the value set will be decreased or increased upon long-time actuation. Only for "control by long actuation? = YES".
Input 1, blocking ["dimming value transmitter"]		
blocking function	released locked	The inhibit function can be disabled or enabled.
polarity blocking object	blocking = 1 (release = 0) blocking = 0 (release = 1)	This parameter specifies the polarity of the inhibit object.
behaviour at begin of blocking	no reaction reaction like rising edge reaction like falling edge transmit current input status	This parameter specifies the response that will be made at the beginning of the inhibition. No response. The value parameterised for the rising edge will be forced to be sent. Only for "transmit value at = rising edge (pushbutton normally open contact)" and "transmit value at = rising and falling edges (switch)". The value parameterised for the falling edge will be forced to be sent. Only for "transmit value at = falling edge (pushbutton normally closed contact)" and "transmit value at = rising and falling edges (switch)". The current status of the inputs according to the parameterisation for the rising and falling edges will be sent. Only for "transmit value at = rising and falling edges (switch)".

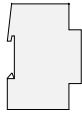

Input 1, blocking ["dimming value transmitter"]		
behaviour at end of blocking	<p>no reaction</p> <p>reaction like rising edge</p> <p>reaction like falling edge</p> <p>transmit current input status</p>	<p>This parameter specifies the response that will be made at the end of the inhibition.</p> <p>No response.</p> <p>The value parameterised for the rising edge will be forced to be sent.</p> <p>Only for "transmit value at = rising edge (pushbutton normally open contact)" and "transmit value at = rising and falling edges (switch)".</p> <p>The value parameterised for the falling edge will be forced to be sent.</p> <p>Only for "transmit value at = falling edge (pushbutton normally closed contact)" and "transmit value at = rising and falling edges (switch)".</p> <p>The current status of the inputs according to the parameterisation for the rising and falling edges will be sent.</p> <p>Only for "transmit value at = rising and falling edges (switch)".</p>
Input 1		
Function input 1 = "call light scenes without memory function"		
transmit light scene number at	<p>rising edge (pushbutton normally open contact)</p> <p>falling edge (pushbutton normally closed contact)</p> <p>rising and falling edges (switch)</p>	<p>Specifies the edge which will initiate an event.</p>
light scene on rising edge (1...127)	1 to 127 (Default 1)	<p>Specifies the light scene which will be sent upon a rising edge.</p> <p>Only for "transmit light scene number at = rising edge (pushbutton normally open contact)" and "transmit light scene number at = rising and falling edges (switch)".</p>
light scene on falling edge (1...127)	1 to 127 (Default 1)	<p>Specifies the light scene which will be sent upon a falling edge.</p> <p>Only for "transmit light scene number at = falling edge (pushbutton normally closed contact)" and "transmit light scene number at = rising and falling edges (switch)".</p>





Input 1		
Function input 1 = "call light scenes without memory function"		
behaviour on bus voltage return	<p>no reaction</p> <p>reaction like rising edge</p> <p>reaction like falling edge</p> <p>transmit current input status</p>	<p>You can specify what response is to be made upon bus voltage recovery. If some delay after bus voltage recovery has been parameterised, this time will first have to have elapsed until the response specified here will be made.</p> <p>No response.</p> <p>The light scene parameterised for the rising edge will be forced to be sent.</p> <p>Only for "transmit light scene number at = rising edge (pushbutton normally open contact)" and "transmit light scene number at = rising and falling edges (switch)".</p> <p>The light scene parameterised for the falling edge will be forced to be sent.</p> <p>Only for "transmit light scene number at = falling edge (pushbutton normally closed contact)" and "transmit light scene number at = rising and falling edges (switch)".</p> <p>The current status of the inputs according to the parameterisation for the rising and falling edges will be sent.</p> <p>Only for "transmit light scene number at = rising and falling edges (switch)".</p>
Input 1, blocking ["call light scenes without memory function"]		
blocking function	<p>released</p> <p>locked</p>	The inhibit function can be disabled or enabled.
polarity blocking object	<p>blocking = 1 (release = 0)</p> <p>blocking = 0 (release = 1)</p>	This parameter specifies the polarity of the inhibit object.



 Input 1, blocking ["call light scenes without memory function"]		
behaviour at begin of blocking	<p>no reaction</p> <p>reaction like rising edge</p> <p>reaction like falling edge</p> <p>transmit current input status</p>	<p>This parameter specifies the response that will be made at the beginning of the inhibition.</p> <p>No response.</p> <p>The value parameterised for the rising edge will be forced to be sent. Only for "transmit light scene number at = rising edge (pushbutton normally open contact)" and "transmit light scene number at = rising and falling edges (switch)".</p> <p>The value parameterised for the falling edge will be forced to be sent. Only for "transmit light scene number at = falling egde (pushbutton normally closed contact)" and "transmit light scene number at = rising and falling edges (switch)".</p> <p>The current status of the inputs according to the parameterisation for the rising and falling edges will be sent. Only for "transmit light scene number at = rising and falling edges (switch)".</p>
behaviour at end of blocking	<p>no reaction</p> <p>reaction like rising edge</p> <p>reaction like falling edge</p> <p>transmit current input status</p>	<p>This parameter specifies the response that will be made at the end of the inhibition.</p> <p>No response.</p> <p>The value parameterised for the rising edge will be forced to be sent. Only for "transmit light scene number at = rising edge (pushbutton normally open contact)" and "transmit light scene number at = rising and falling edges (switch)".</p> <p>The value parameterised for the falling edge will be forced to be sent. Only for "transmit light scene number at = falling egde (pushbutton normally closed contact)" and "transmit light scene number at = rising and falling edges (switch)".</p> <p>The current status of the inputs according to the parameterisation for the rising and falling edges will be sent. Only for "transmit light scene number at = rising and falling edges (switch)".</p>



 Input 1		
 Function input 1 = "call light scenes with memory function"		
transmit light scene number at	rising edge (pushbutton normally open contact) falling egde (pushbutton normally closed contact)	Specifies the edge which will initiate an event.
light scene on rising edge (1...127)	1 to 127 (Default 1)	Specifies the light scene which will be sent upon a rising edge. Only for "transmit light scene number at = rising edge (pushbutton normally open contact)".
light scene on falling edge (1...127)	1 to 127 (Default 1)	Specifies the light scene which will be sent upon a falling edge. Only for "transmit light scene number at = falling egde (pushbutton normally closed contact)".
behaviour on bus voltage return	no reaction reaction like rising edge reaction like falling edge	You can specify what response is to be made upon bus voltage recovery. If some delay after bus voltage recovery has been parameterised, this time will first have to have elapsed until the response specified here will be made. No response. The light scene parameterised for the rising edge will be forced to be sent. Only for "transmit light scene number at = rising edge (pushbutton normally open contact)". The light scene parameterised for the falling edge will be forced to be sent. Only for "transmit light scene number at = falling egde (pushbutton normally closed contact)".
only memory function?	YES NO	You can send only a save message without previously calling a light scene.

instabus EIB System

Sensor



Input 1		
Function input 1 = "call light scenes with memory function"		
time for long actuation to memorise base	130 ms ¹⁾ 260 ms ²⁾ 520 ms ³⁾ 1 s ⁴⁾	Long-time actuation time base for sending a save message. Only for "only memory function? = NO". Time = base · factor
time for long actuation to memorise factor (24...127) ¹⁾ factor (13...127) ²⁾ factor (9...127) ³⁾ factor (4...127) ⁴⁾	24 bis 127 (Default 38) ¹⁾ 13 bis 127 (Default 19) ²⁾ 9 bis 127 (Default 10) ³⁾ 4 bis 127 (Default 5) ⁴⁾	Long-time actuation time factor base for sending a save message. Only for "only memory function? = NO". Time = base · factor Presetting: 520 ms · 10 = 5.2 s Important: The factor range depends on the base set. This way, times of > 3 s can be exclusively parameterised.
Input 1, blocking ["call light scenes with memory function"]		
blocking function	released locked	The inhibit function can be disabled or enabled.
polarity blocking object	blocking = 1 (release = 0) blocking = 0 (release = 1)	This parameter specifies the polarity of the inhibit object.
behaviour at begin of blocking	no reaction reaction like rising edge reaction like falling edge	This parameter specifies the response that will be made at the beginning of the inhibition. No response. The value parameterised for the rising edge will be forced to be sent. Only for "transmit light scene number at = rising edge (pushbutton normally open contact)". The value parameterised for the falling edge will be forced to be sent. Only for "transmit light scene number at = falling edge (pushbutton normally closed contact)".



Input 1, blocking ["call light scenes with memory function"]		
behaviour at end of blocking	<p>no reaction</p> <p>reaction like rising edge</p> <p>reaction like falling edge</p>	<p>This parameter specifies the response that will be made at the end of the inhibition.</p> <p>No response.</p> <p>The value parameterised for the rising edge will be forced to be sent.</p> <p>Only for "transmit light scene number at = rising edge (pushbutton normally open contact)".</p> <p>The value parameterised for the falling edge will be forced to be sent.</p> <p>Only for "transmit light scene number at = falling edge (pushbutton normally closed contact)".</p>
Input 1		
Function input 1 = "temperature value transmitter"		
transmit value at	<p>rising edge (pushbutton normally open contact)</p> <p>falling edge (pushbutton normally closed contact)</p> <p>rising and falling edges (switch)</p>	<p>Specifies the edge which will initiate an event.</p>
value at rising edge	<p>0 to 40 °C in 1 °C increments (Default 20 °C)</p>	<p>Setting the temperature value to be sent.</p> <p>Only for "transmit value at = rising edge (pushbutton normally open contact)" and "transmit value at = rising and falling edges (switch)".</p>
value at falling edge	<p>0 to 40 °C in 1 °C increments (Default 18 °C)</p>	<p>Setting the temperature value to be sent.</p> <p>Only for "transmit value at = falling edge (pushbutton normally closed contact)" and "transmit value at = rising and falling edges (switch)".</p>

Sensor



Input 1		
Function input 1 = "temperature value transmitter"		
behaviour on bus voltage return	<p>no reaction</p> <p>reaction like rising edge</p> <p>reaction like falling edge</p> <p>transmit current input status</p>	<p>You can specify what response is to be made upon bus voltage recovery. If some delay after bus voltage recovery has been parameterised, this time will first have to have elapsed until the response specified here will be made.</p> <p>No response.</p> <p>The value parameterised for the rising edge will be forced to be sent.</p> <p>Only for "transmit value at = rising edge (pushbutton normally open contact)" and "transmit value at = rising and falling edges (switch)".</p> <p>The value parameterised for the falling edge will be forced to be sent.</p> <p>Only for "transmit value at = falling edge (pushbutton normally closed contact)" and "transmit value at = rising and falling edges (switch)".</p> <p>The current status of the inputs according to the parameterisation for the rising and falling edges will be sent.</p> <p>Only for "transmit value at = rising and falling edges (switch)".</p>
control by long actuation?	<p>YES</p> <p>NO</p>	<p>Upon a long-time actuation (< 5 s), the current value can be sent in a cyclic manner decreased or increased by the parameterised step width (see below). After this value change, the value sent last will be kept stored.</p> <p>This parameter determines whether value changing will be possible.</p> <p>Only for "transmit value at = rising edge (pushbutton normally open contact)" and "transmit value at = falling edge (pushbutton normally closed contact)".</p>



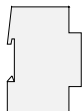

Input 1		
Function input 1 = "temperature value transmitter"		
time between two telegrams base	130 ms 260 ms 520 ms 1 s	Time base between two cyclic messages for value changing. Only for "control by long actuation? = YES". Time = base · factor
time between two telegrams factor (3...127)	3 to 127 (Default 3)	Time factor between two cyclic messages for value changing. Only for "control by long actuation? = YES". Time = base · factor Presetting: 520 ms · 3 = 1.56 s
step size	1 °C	Step width by which the value set will be decreased upon long-time actuation.
Input 1, blocking ["temperature value transmitter "]		
blocking function	released locked	The inhibit function can be disabled or enabled.
polarity blocking object	blocking = 1 (release = 0) blocking = 0 (release = 1)	This parameter specifies the polarity of the inhibit object.
behaviour at begin of blocking	no reaction reaction like rising edge reaction like falling edge transmit current input status	This parameter specifies the response that will be made at the beginning of the inhibition. No response. The value parameterised for the rising edge will be forced to be sent. Only for "transmit value at = rising edge (pushbutton normally open contact)" and "transmit value at = rising and falling edges (switch)". The value parameterised for the falling edge will be forced to be sent. Only for "transmit value at = falling edge (pushbutton normally closed contact)" and "transmit value at = rising and falling edges (switch)". The current status of the inputs according to the parameterisation for the rising and falling edges will be sent. Only for "transmit value at = rising and falling edges (switch)".



Input 1, blocking ["temperature value transmitter "]		
behaviour at end of blocking	<p>no reaction</p> <p>reaction like rising edge</p> <p>reaction like falling edge</p> <p>transmit current input status</p>	<p>This parameter specifies the response that will be made at the end of the inhibition.</p> <p>No response.</p> <p>The value parameterised for the rising edge will be forced to be sent.</p> <p>Only for "transmit value at = rising edge (pushbutton normally open contact)" and "transmit value at = rising and falling edges (switch)".</p> <p>The value parameterised for the falling edge will be forced to be sent.</p> <p>Only for "transmit value at = falling edge (pushbutton normally closed contact)" and "transmit value at = rising and falling edges (switch)".</p> <p>The current status of the inputs according to the parameterisation for the rising and falling edges will be sent.</p> <p>Only for "transmit value at = rising and falling edges (switch)".</p>
Input 1		
Function input 1 = "brightness value transmitter"		
transmit value at	<p>rising edge (pushbutton normally open contact)</p> <p>falling edge (pushbutton normally closed contact)</p> <p>rising and falling edges (switch)</p>	<p>Specifies the edge which will initiate an event.</p>
value at rising edge	<p>0 to 1500 lux in 50 lux increments (Default 200 lux)</p>	<p>Setting the brightness value to be sent.</p> <p>Only for "transmit value at = rising edge (pushbutton normally open contact)" and "transmit value at = rising and falling edges (switch)".</p>
value at falling edge	<p>0 to 1500 lux in 50 lux increments (Default 0 lux)</p>	<p>Setting the brightness value to be sent.</p> <p>Only for "transmit value at = falling edge (pushbutton normally closed contact)" and "transmit value at = rising and falling edges (switch)".</p>



 Input 1		
 Function input 1 = "brightness value transmitter"		
behaviour on bus voltage return	<p>no reaction</p> <p>reaction like rising edge</p> <p>reaction like falling edge</p> <p>transmit current input status</p>	<p>You can specify what response is to be made upon bus voltage recovery. If some delay after bus voltage recovery has been parameterised, this time will first have to have elapsed until the response specified here will be made.</p> <p>No response.</p> <p>The value parameterised for the rising edge will be forced to be sent.</p> <p>Only for "transmit value at = rising edge (pushbutton normally open contact)" and "transmit value at = rising and falling edges (switch)".</p> <p>The value parameterised for the falling edge will be forced to be sent.</p> <p>Only for "transmit value at = falling edge (pushbutton normally closed contact)" and "transmit value at = rising and falling edges (switch)".</p> <p>The current status of the inputs according to the parameterisation for the rising and falling edges will be sent.</p> <p>Only for "transmit value at = rising and falling edges (switch)".</p>
control by long actuation?	<p>YES</p> <p>NO</p>	<p>Upon a long-time actuation (< 5 s), the current value can be sent in a cyclic manner decreased or increased by the parameterised step width (see below). After this value change, the value sent last will be kept stored.</p> <p>This parameter determines whether value changing will be possible.</p> <p>Only for "transmit value at = rising edge (pushbutton normally open contact)" and "transmit value at = falling edge (pushbutton normally closed contact)".</p>

instabus EIB System

Sensor



Input 1		
Function input 1 = "brightness value transmitter"		
time between two telegrams base	130 ms 260 ms 520 ms 1 s	Time base between two cyclic messages for value changing. Only for "control by long actuation? = YES". Time = base · factor
time between two telegrams factor (3...127)	3 to 127 (Default 3)	Time factor between two cyclic messages for value changing. Only for "control by long actuation? = YES". Time = base · factor Presetting: 520 ms · 3 = 1.56 s
step size	50 lux	Step width by which the value set will be decreased upon long-time actuation.
Input 1, blocking ["brightness value transmitter "]		
blocking function	released locked	The inhibit function can be disabled or enabled.
polarity blocking object	blocking = 1 (release = 0) blocking = 0 (release = 1)	This parameter specifies the polarity of the inhibit object.
behaviour at begin of blocking	no reaction reaction like rising edge reaction like falling edge transmit current input status	This parameter specifies the response that will be made at the beginning of the inhibition. No response. The value parameterised for the rising edge will be forced to be sent. Only for "transmit value at = rising edge (pushbutton normally open contact)" and "transmit value at = rising and falling edges (switch)". The value parameterised for the falling edge will be forced to be sent. Only for "transmit value at = falling edge (pushbutton normally closed contact)" and "transmit value at = rising and falling edges (switch)". The current status of the inputs according to the parameterisation for the rising and falling edges will be sent. Only for "transmit value at = rising and falling edges (switch)".



Input 1, blocking ["brightness value transmitter "]		
behaviour at end of blocking	<p>no reaction</p> <p>reaction like rising edge</p> <p>reaction like falling edge</p> <p>transmit current input status</p>	<p>This parameter specifies the response that will be made at the end of the inhibition.</p> <p>No response.</p> <p>The value parameterised for the rising edge will be forced to be sent.</p> <p>Only for "transmit value at = rising edge (pushbutton normally open contact)" and "transmit value at = rising and falling edges (switch)".</p> <p>The value parameterised for the falling edge will be forced to be sent.</p> <p>Only for "transmit value at = falling edge (pushbutton normally closed contact)" and "transmit value at = rising and falling edges (switch)".</p> <p>The current status of the inputs according to the parameterisation for the rising and falling edges will be sent.</p> <p>Only for "transmit value at = rising and falling edges (switch)".</p>
Input 1		
Function input 1 = "pulse counter"		
counting of pulses at input by	<p>rising edge</p> <p>falling edge</p> <p>rising and falling edges</p>	<p>This parameter specifies at which edge pulses will be counted at the input.</p>
transmit interval time for pulse counter base	<p>2,1 s</p> <p>4,2 s</p> <p>8,4 s</p> <p>17 s</p> <p>34 s</p>	<p>Interval time base.</p> <p>After this time has elapsed, the count will be sent to the bus, the counter being reset for pulse counting during the next time interval.</p> <p>Time = base · factor</p>
transmit interval time for pulse counter factor (3...127)	<p>3 to 127 (Default 30)</p>	<p>Interval time factor.</p> <p>After this time has elapsed, the count will be sent to the bus, the counter being reset for pulse counting during the next time interval.</p> <p>Time = base · factor</p> <p>Presetting: 2.1 s · 30 = 63 s</p>

instabus EIB System

Sensor

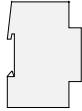

Input 1		
Function input 1 = "pulse counter"		
reset counter status and interval time by synchronous signal at	rising edge falling edge rising and falling edges	This parameter specifies at which edge of the sync signal the count and the interval time will be reset.
telegram at receiving a synchronous signal	Rising edge = ON, falling edge = --- Rising edge = OFF, falling edge = --- Rising edge = TOGGLE, falling edge = --- Rising edge = ---, falling edge = ON Rising edge = ---, falling edge = OFF Rising edge = ---, falling edge = TOGGLE Rising edge = ON, falling edge = OFF Rising edge = OFF, falling edge = ON Rising edge = TOGGLE, falling edge = TOGGLE Rising edge = ---, falling edge = ---	Upon receipt of a sync signal, switch messages can be sent to the bus, independently of the sync signal edge. The output value will be assigned to the edge. Note: This edge assignment is independent of the edge assignment for resetting the count and the interval time (parameter " reset counter status and interval time by synchronous signal at ").
Input 1, blocking ["pulse counter"]		
		No inhibit function possible.



Input 1		
Function input 1 = "switching counter"		
'counting of pulses at input by'	rising edge falling egde rising and falling edges	This parameter specifies at which edge pulses will be counted at the input.
max. counter position (1...65535)	1 to 65535 (Default 65535)	Maximum count at which the same will be transmitted to the bus. After the transmission, the counter will be automatically and internally reset.
command at max. counter position	no telegram ON OFF TOGGLE	Signal value which will be sent to the bus when the maximum count is reached.
step size counter output (1...255)	1 to 255 (Default 255)	Defines the step width (number of counting pulse) on the basis of which the current count will be output.
Input 1, blocking ["switching counter"]		
		No inhibit function possible.
For input 2, refer to input 1.		
For input 3, refer to input 1, however, without "pulse counter" and "switching counter".		
For input 4, refer to input 1, however, without "pulse counter" and "switching counter".		
For input 5, refer to input 1, however, without "pulse counter" and "switching counter".		
For input 6, refer to input 1, however, without "pulse counter" and "switching counter".		
For input 7, refer to input 1, however, without "pulse counter" and "switching counter".		
For input 8, refer to input 1, however, without "pulse counter" and "switching counter".		

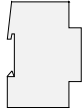

Remarks on the software

- **Bus voltage recovery**

You can specify for each input what response is to be made upon bus voltage recovery. If some delay after bus voltage recovery has been parameterised, this time will first have to have elapsed until the response set will be made. Within the delay, any edges or signals applied to the inputs will be discarded. The delay time should, in general, be parameterised for all inputs.

You can parameterise some message rate limitation. In such case, no message will be sent within the first 17 s after bus voltage recovery. Please note that any possibly parameterised delay after bus voltage recovery may also be active during this time.

Any edge or signal applied to the inputs upon bus voltage recovery will be discarded.

- **Blocking function**

At the beginning or at the end of an blocking, an independent response can be made to each input. In this connection, you can set your parameterisation to "no reaction". Only in such case, any dimming or blind/shutter control or value changing events running before the activation of any blocking will be completed during an active blocking. In any other cases, the parameterised command will be sent immediately at the beginning of an blocking. Moreover, any edges or signals at the corresponding inputs will not be accepted during an active blocking.

Updates on inhibit objects (disable or enable) each time cause the corresponding parameterised command to be sent "at the beginning or end of the blocking".

During an active blocking, there will be no cyclic sending through the disabled input. If cyclic sending was taking place prior to an activation of the inhibit function, no more cyclic sending will be performed at the end of the blocking, provided that "no reaction" has been parameterised. In this case, the cyclic transmission of the object value will only be effected again after an update on the switching object. In any other cases, the object value will be sent in cycles again after the end of the blocking.

- **Cyclic sending**

The object value corrected internally in the switching objects or externally will always be sent. Cyclic sending after bus voltage recovery will only take place after an edge has appeared at the input in accordance with the object value parameterisation for cyclic sending. Thus, the object value will also be sent in cycles, if "no reaction" has been assigned to a rising or falling edge.

During an active inhibition, there will be no cyclic sending through the disabled input.