

**Electronic Louver Control**  
**Insert without neutral conductor**

Order no.: 0395 00

**1. Function**

The louver insert without neutral conductor is used in electrical installations without neutral conductor (N).

The existing mechanical shutter switch can therefore be replaced directly by a comfortable control unit with the blind/shutter insert without neutral conductor.

The louver insert without neutral conductor is a component of the Louver Control System and is used in conjunction with attachments of the Louver Control System in a mounting box acc. to DIN 49073 (deep box recommended).

By replacing the attachment it is therefore possible to realize systems with manual operation, comfortable operation by radio remote control or timercontrolled fully automatic operation.

The insert is equipped with two mechanically interlocked relay power contacts.

The simultaneous activation of both moving directions of the shutter motor connected is thus excluded.

The insert has 3 connecting terminals (1) and a 6-pole interface connector (2) for connection of the attachment.

In addition, a 3-pole terminal block (3) can be placed into the insert (supplied with inserts with sensor input).

This terminal block can be used to connect different sensors to the insert when attachments with sensor input are installed:

- Sun protection / twilight sensor (order no. 0930 00)
- Glass breakage sensor (order no. 0931 00)

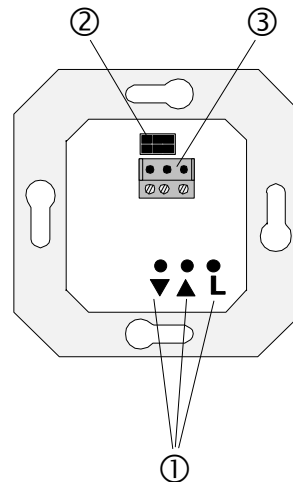

**⚠ Attention:**  
Connect only one motor with limit switches and a power consumption of 1000 W max. to each insert. Do not use isolating relays. It is absolutely necessary to check the motor for suitability as described in chapter 4.

**2. Equipment combinations**

Depending on the attachment used, the following functions can be implemented:

**Control push-button** (order no. 0644 .., 0820 ..)  
Pushbutton for manual operation.  
(see 'control push-button' operating instructions).

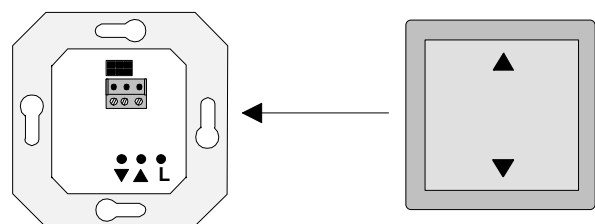

**Radio control push-button with sensor evaluation (order no. 0545 ..)**

Pushbutton for manual and radio remote-control operation (see 'radio control push-button with sensor evaluation' operating instructions).

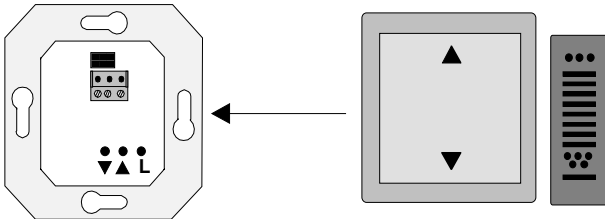

**Control push-button with memory function (order no. 0822 ..)**

Pushbutton for manual operation with additional automatic control.

With its memory function for an UP and a DOWN movement, this attachment permits simple and individual programming.

Both shutter movement times are repeated once every 24 hours (see 'control push-button with memory function' operating instructions)

If the above attachments are used in the versions with sensor input, the glass breakage alarm and sun protection functions can also be implemented.

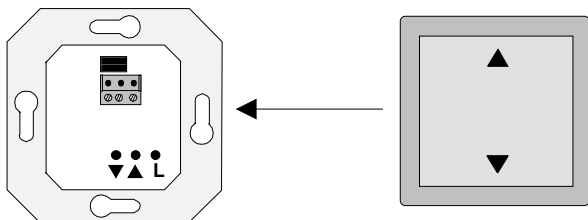

**Electronic louver control easy or Comfort electronic louver control**

Timer for automatic control with programmable switching times.

See also the operating instructions of:

Electronic louver control easy (order no. 0841 ..) and Comfort electronic louver control (order no. 0646 .., 0823 ..).

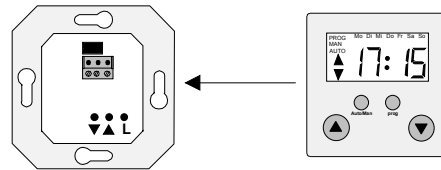

When the versions with sensor input are used, the following functions are available in addition:

- glass breakage alarm
- sun protection function
- twilight function

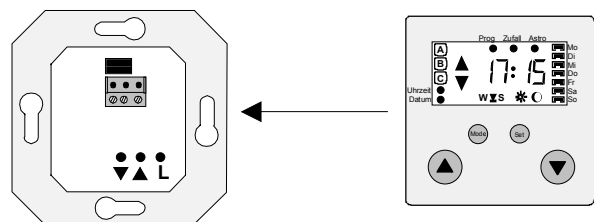

**3. Instructions**

Use blind/shutter motors with mechanical or electronic limit switches only.

Check the blind/shutter motor for suitability in compliance with the instructions set out in chapter 4 before using it in conjunction with the louver insert without neutral conductor.

Do not use isolating relays. With such relays, the blind/shutter control has no power supply through the motor winding. Risk of malfunction.

Observe the instructions of the motor manufacturers concerning the switchover time and the maximum load factor (c.d.f.).

The louver insert without neutral conductor must only be used in conjunction with one of the following attachments:

- push-button
- radio control push-button
- push-button with memory function
- electronic louver control easy
- Comfort electronic louver control



**Notes:**

The electronic interlocking of the attachment permits to obtain a minimum switch-over time of approx. 1 second in the continuous run mode.

If the user desires to operate a louver-blind/shutter motor in addition to local switching also from a master control (e.g. central control system) it is necessary to use the Comfort louver control insert (order no. 0398 00) which is equipped with extension inputs.

If it is necessary to prolong the sensor line, use an appropriate type of sensor cable. Recommendation: J-Y(ST)Y 2x2x0.6 mm.

**4. Checking the motors for suitability**

Often, it is not known whether the motor installed is equipped with mechanical or electronic limit switches.



**Therefore:  
Check the motor first for suitability**

Some motors with mechanical limit switches tend to build up a high motor voltage in operation which may irreparably damage the louver insert without neutral conductor. Checking is therefore effected with a commercial mechanical shutter switch (possibly still installed) and not with the louver insert without neutral conductor.

Carry out the following measurement using a voltmeter:

- Measure the actual mains voltage  $U_N$
- Go to the measured mains voltage on the left side of the diagram opposite.
- Draw a straight line from the value found through the center M to the righthand axis. The intersection of the line and the right axis is the maximum permissible motor voltage  $U_M$ .
- Measure the motor voltage  $U_M$  in the UP and DOWN direction on the installed mechanical shutter switch. The maximum value as determined above must not be exceeded when the measurements are made.

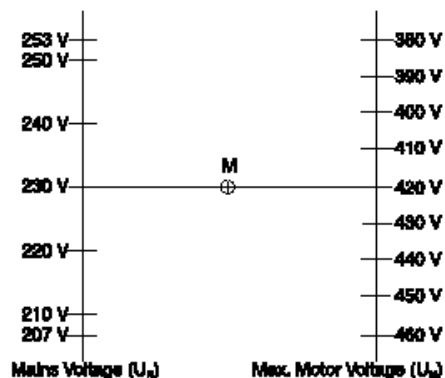
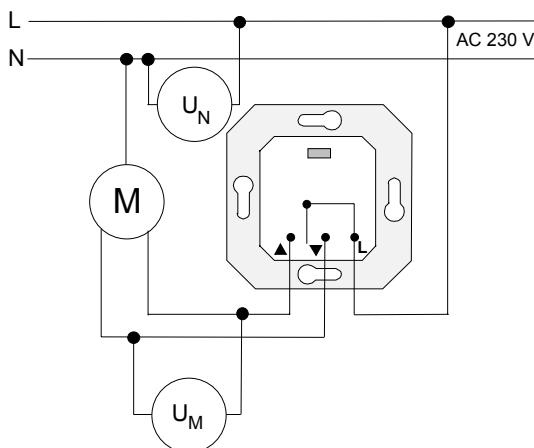

**Example:**

The measured mains voltage  $U_N$  is 221 V. Draw a straight line from 221 V on the left through the center of the diagram (M) to the right side with motor voltage  $U_M$ . The the maximum permissible motor voltage in this case is 404 V.

The voltages measured for the UP and DOWN directions must therefore be below 404 V.

:

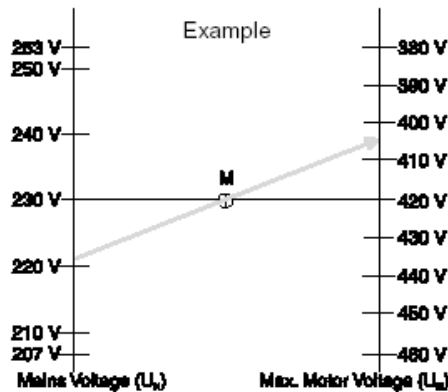

Approximate values for typical maximum motor voltages  $U_M$  as a function of the mains voltage  $U_N$  are set out in the table opposite.

$U_n$	max. $U_m$
207 V	380 V
215 V	393 V
220 V	403 V
225 V	412 V
230 V	420 V
235 V	429 V
240 V	438 V
245 V	447 V
253 V	460 V

**Motor with electronic limit switches**

If it is certain that the motor used is one with electronic limit switches, the measurement described above can be dispensed with.

It is not possible to damage the insert with motors equipped with electronic limit switches if these are used in conformity with their designated use.

In this case, check the basic functions of the motor in combination with the louver insert without neutral conductor as follows:

- Install the louver insert without neutral conductor as described in chapter 5.
- Plug a shutter control attachment into the insert.
- Test the functions of the shutter control in several trial runs with the motor connected.

**5. Connection and fitting**

The louver insert without neutral conductor is connected in acc. with the following figure.

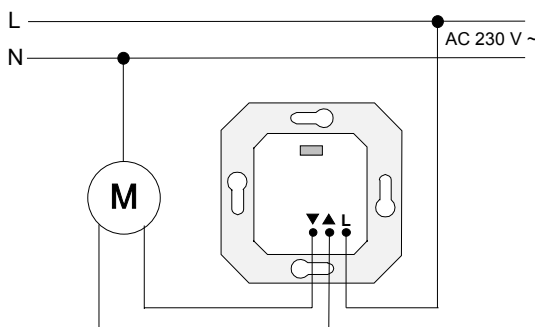

Install the louver insert without neutral conductor (1) in a mounting box in acc. with DIN 49073 (deep box recommended).

The connecting terminals of the insert must be at the bottom.

Plug the attachment (2) together with frame (3) into the insert.

The electrical contact is established through connector (4).

The additional contact pins (5) in attachments with sensor input make automatic contact with the 3-pole terminal block placed into the insert.

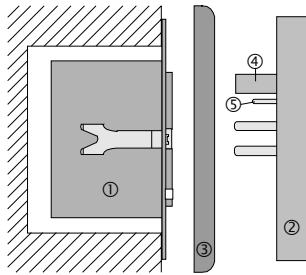

## 6. Installation with sensors



### Important:

The sensor cable carries safety extra low voltage (SELV). Observe the installation rules in acc. with VDE 0100. The installation of the sensors varies with the type of installation (flushmounting or surface-mounting) and with the attachment used. The sensor cable is factory-equipped with a connector.

### Direct connection of the sensor cable to the attachment

If the attachment is equipped with a jack, the sensor is simply connected to the attachment by plugging the connector into the jack.

The connector is polarized so that it can be plugged in only in the correct position (see attachment operating instructions).

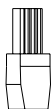
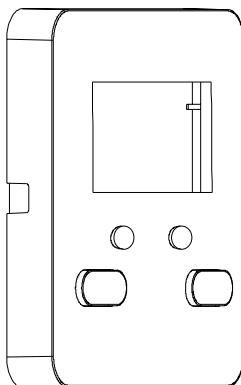

### Flush-mounting installation of sensor cable

The sensor cable is laid in a cable duct inside the insert.

- Cut off the connector at the end of the sensor cable.
- Slide the insulating sleeve (supplied with attachments with sensor input) over the sensor cable.
- Stick the sleeved cable through the hole (1) of the insert.  
The insulating sleeve must cover the sensor cable over the full length from the flush-mounting box to the cable duct (2).
- Pass the cable with the insulating sleeve through the duct (2) to the terminal block (3).  
The cable must follow the duct closely without any loops in the 230 V section of the insert.
- Place the terminal block (supplied with attachments with sensor input) into the insert as shown in the illustration (screws at the bottom).

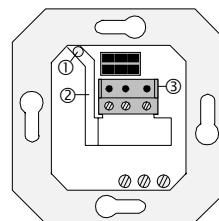

**Surface-mounting of sensor cable, version 1**

The cable is passed through the cable duct in the insert.

- Pass the the sensor cable (1) through opening (2) behind the supporting frame (between wall and supporting frame) into the cable duct (3) in the insert.
- Lead the cable directly through the duct to the terminal block (4). The cable must follow the duct closely without any loops in the 230 V section of the insert.

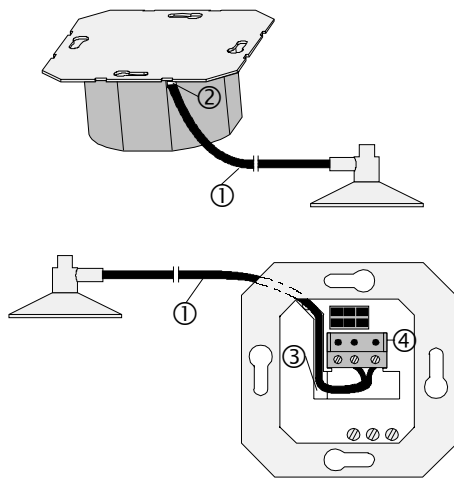

**Surface-mounting of sensor cable, version 2**

The cable is passed through the cable duct in the attachment.

- Pass the sensor cable (1) through the cable duct in the attachment (2) to the terminal block in the insert.

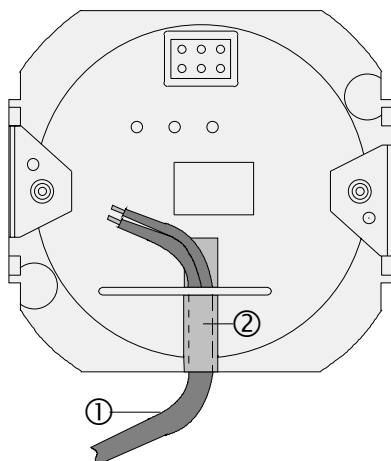

**Connection to the terminal block in the insert:**

Connect the sensor cable in acc. with fig. E. The screws of the block must be at the bottom.

- Left: glass breakage sensor signal line
- Center: ground
- Right: sun / twilight sensor signal line

Wire marking:

- Sensors:
  - 'Ground' = marked grey
- Adapter and extension cable:
  - 'Sun' = marked grey
  - 'Ground' = middle wire

If the the sun / twilight sensor and the glass breakage sensor are to be used at the same time, an adapter must be installed (to be ordered separately).

Connect the adapter directly to the attachment by means of the connector or to the insert with the 3-pole terminal block (connector cut off).

The adapter is equipped with 2 jacks for connection of the sensor plugs.

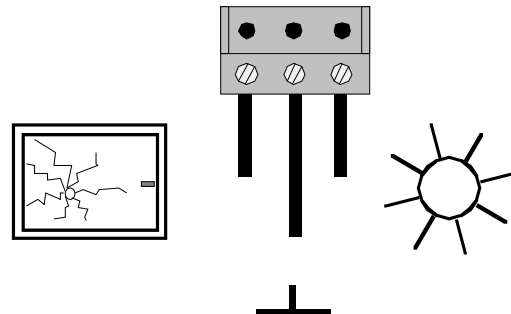

## 7. Technical data

Rated voltage:	AC 230 V ~, 50 Hz N-conductor not required	Electronic louver control easy:	2 minutes
Switching capability:	max. 1 motor with 1000 W	Comfort electronic louver control:	standard value 2 minutes programmed: 1 second - 12 minutes
Relay output:	2 non-floating n.o. contacts (mutually interlocked)		
Pulse time Control push-button:	2 minutes	Switch-over in continuous run mode:	min. 1 second (electronic interlock in attachment)
Control push-button with memory function:	2 minutes	Connecting terminals:	screw terminals for 2.5 mm <sup>2</sup> max. or 2x 1.5mm <sup>2</sup>
Radio control push- button with sensor evaluation:	2 minutes	Circuit-breaker:	16 A max.

## Acceptance of guarantee

We accept the guarantee in accordance with the corresponding legal provisions.

**Please return the unit postage paid to our central service department giving a brief description of the fault:**

Gira  
Giersiepen GmbH & Co. KG  
**Service Center**  
Dahlienstrasse 12  
D-42477 Radevormwald



The CE sign is a free trade sign addressed exclusively to the authorities and does not include any warranty of any properties.

Gira  
Giersiepen GmbH & Co. KG  
Postfach 1220  
D-42461 Radevormwald

Telefon: +49 / 21 95 / 602 - 0  
Telefax: +49 / 21 95 / 602 - 339  
Internet: [www.gira.de](http://www.gira.de)